

Contents

	Page
1. GENERAL INFORMATION	
1.1 Description	3
1.2 Dyna-Mite Specifications.....	3
1.3 Introduction to Dynamics Processing	3
A. Overview	3
B. Threshold/Attack/Release.....	4
C. Detector Circuits	5
D. Transient Material Response	5
E. Release Circuit	6
F. Gain Control Elements	6
2. INSTALLATION	
2.1 Connecting Dyna-Mite to Other Equipment	6
2.2 Accessories.....	8
3. THEORY OF OPERATION	
3.1 Block Diagram	8
3.2 Circuit Description	9
4. OPERATING INSTRUCTIONS	
4.1 The Controls	10
4.2 Using Dyna-Mite—Its Operating Modes	11
A. Limiting Functions.....	11
1. General Use for Apparent Level Control	11
2. Peak Limiting for Broadcast/Disc Cutting	11
3. FM Pre-emphasized Limiting.....	11
4. DS Limiting	11
B. Expanding Functions.....	12
5. General Noise Reduction via 1:2 Expansion	12
6. Noise Gating for Percussive and Defined Signal Sources	12
7. Noise Gating or Noise Expanding, Using FM/DS Filter	13
8. Noise Gating or Expanding, Using an External Equalizer	13
C. Keying, Ducking and Envelope Following	13
9. Keying Effects	13
10. Envelope Following.....	13
11. Ducking Effects	13
12. Inverse Envelope Following	14
13. Range Controlled Negative Limiting.....	14
4.3 Functional Modes Reference Chart	14
5. MAINTENANCE	
5.1 Brief Circuit Information.....	15
5.2 Adjusting the Trim Pots.....	15
1. Detector Balance Trim (R18)	15
2. Threshold Trim (R24)	15
3. VCA Rejection Trim (R101).....	15
5.3 Warranty	15
6. ILLUSTRATIONS	
6.1 Graphs of Control Function	16
6.2 Schematic Drawing.....	17
6.3 Parts Overlay	18
6.4 Power Supply	19

1. General Information

1.1 DESCRIPTION

The Valley People DYNA-MITE is a self-contained and self-powered multi-purpose processing device. In all, it is capable of operating in 18 specific modes, including the basic modes of Limiting, Expansion, De-essing, Noise Gating, Ducking, Keying, etc.

In the Limiting mode alone, there are a number of specific derivations, such as Peak Limiting, Linear Integration Limiting, FM Pre-emphasized Limiting and Side Chain Controlled Limiting.

Similar derivations are evident in the other basic operating modes.

The selection of operating modes is straightforward and understandable, as indicated by three front panel switches, each having three positions.

In each operating mode, full parametric control is afforded by four continuously variable controls. Thus, while being easy to operate, DYNA-MITE is capable of satisfying the most critical of demands for performance.

The device is fully metered, with an 8 element LED Gain Reduction Array, plus clipping indicator.

Balanced input circuitry capable of +24dBv is employed to assure compatibility with professional equipment, while the circuitry is structured to interface correctly to low level/high impedance semi-pro components. The output circuit can deliver a full +21dBm into 600 ohm loads or transformers, yet can feed -10dBv lines with excellent noise levels and compatibility.

The circuitry employed represents the highest possible technology, for excellence of performance in any system.

Every effort has been put forth in the packaging of DYNA-MITE, to assure a simple, yet reliable interface: professional type ring/tip/sleeve jacks; 110/220VAC operation; adaptability to battery power and rack mounting. Stereo coupling is accomplished by pressing a front panel switch.

The case itself is unique. An injection-molded, high-impact-strength instrument case, with RFI shielding, ready to travel. Yet, it offers modular electronics—mix or match DYNA-MITE 410 modules with future Valley People 400 Series modules to create exactly the right processing package for your needs. All in all, it's DYNA-MITE!

1.2 DYNA-MITE SPECIFICATIONS

Gain Reduction Range: Variable, 60dB Max to 0dB Min

Maximum Input Level: +24dBv

Maximum Output Level: +21dBm - 600 ohms

Static Distortion: .04% THD Maximum @ 1KHz

Dynamic Distortion: Dependent on settings—Anticipatory Release Computation reduces dynamic distortion 10 to 1 over conventional devices

Signal/Noise Ratio: 90dB @ +4dBv in and out @ +4dBv Threshold

Frequency Response: +/- 1dB, 10Hz to 50KHz

Slew Rate: 13V/ μ s (150KHz full power bandwidth)

Attack Time (Peak Detection): 50 μ s/20dB

(Linear Integration Detection): 1ms to 15 ms, signal dependent

Release Time: Variable, 50ms to 5sec/20dB

Threshold: Variable, -40dBv to +20dBv

Output Gain (Exp/Duck/Gate Modes): Variable, +/- 15dB

Output Level (Limit/De-ess Modes): Variable, -15dBv to +15dBv

Limiting Ratio: Infinity:1

Expansion Ratio: 1:2

Gating Ratio: 1:20

Ducking Ratio/Negative Limiting: 1:-20

Front Panel Switches(3): Detector: Avg/Peak/Gate-Duck; Detector: Internal/External/DS-FM; Mode: Limit/Expand/Out (Bypass)

Front Panel Variable Controls (4): Threshold; Release Time; Range (Certain Modes); Output Gain/Level

Powering: 110VAC/220VAC (5 watts); External Battery Requirements: Minimum of +/- 18VDC (72ma for mono unit; 144ma for stereo unit)

Packaging: 3 1/2" x 8 1/2" x 9" Instrument Case holds 2 channels; Rack mount adaptor mounts one or two units in 3 1/2" x 19"

Metering: 8 LED Gain Reduction Metering Array; 1 LED Overload Monitor

Rear Panel Connectors (4): Signal Input; Ext Input (Side Chain input); Signal Output; Control Voltage Out/In

Required Mating Plugs (Not Included): 1/4" Diameter, 3 Conductor Commercial or Telephone/Mil. Plugs (Examples: Mil. #PJ 051; Switchcraft #482 or equivalent; Switchcraft #260 or equivalent)

Note: Specifications subject to change without notice.

1.3 INTRODUCTION TO DYNAMICS PROCESSING

A. Dyna-Mite is a powerful tool for the processing of audio signal dynamics. Its fullest potential may be realized only after the user has acquainted himself with its operation, and become familiar with its controls. To this end, it is recommended that the user take time to carefully read over the information contained herein.

Dynamics processing is simply what the name implies—manipulating the dynamics of an audio signal. The two processes with which we are most familiar are COMPRESSION or LIMITING, and EXPANSION. They are essentially opposite functions. Compression or limiting involves automatically lowering the signal gain as the signal *increases*, thereby reducing, restricting or limiting the dynamic range. Expansion results when the signal gain is lowered as the signal level *decreases*, thereby extending the dynamic range.

The degree to which signal gain is altered in response to a *change* in signal level is called the RATIO. Ratio, be it limiting ratio, compression ratio, or expansion ratio, is expressed as the ratio between a signal level *change* at the input of the device, vs the signal level *change* at the device output. In a linear amplifier, the relationship of input change to output change is direct; thus the ratio is stated as 1:1... a 1dB increase in input signal level produces a 1dB increase in output level. A "perfect" limiter has a ratio of infinity:1. Thus, during limiting, an infinite increase of input signal level is required to produce a 1dB increase in output level. Accordingly, the output is maintained at a constant "clamped" output level, and a "leveled" output results whenever the device is limiting.

Limiter-like devices whose ratio is less than 8:1 are normally termed compressors. For example, a device having a 2:1 ratio will output a 1dB increase in level for each 2dB level increase at the input. Compressors are seldom used in modern signal processing (except in compress/expand noise reduction systems and "canned" music systems). Some manufacturers offer compressor/limiters wherein the compression feature is included as a watered down form of limiting, to be used in situations where the use of full limiting results in audible degradations to the dynamics. The result, of course, is a less than optimum control of signal dynamics... a compromise.

In the Dyna-Mite structure, we have chosen to deal with the detector mechanism, which can cause dynamics degradation, in order to allow full control while maintaining dynamic integrity.

Looking at the expansion end of the spectrum, let us visualize a device having a ratio of 1:2. This means a 1dB input level change will cause a 2dB output change. This action tends to make loud sounds louder, and soft sounds softer. For the sake of not overloading the systems which follow an expander, expansion in a device like Dyna-Mite is normally kept in the region of making soft sounds softer, or downward expansion. When an output gain control is included in the device, though, it becomes somewhat arbitrary as to whether the expander is "downward" or "bi-directional". To clarify, assume the output gain control were set for a nominal gain of +10dB, and expansion action were introduced. In such a setup, the louder signals could be made to appear at the output 10dB higher than the input signal level, thus producing "upward expansion". In using such a structure, however, the user would have to insure that the equipment following the expander were capable of accepting the increased output signal level without overloading.

The relatively mild 1:2 expansion ratio is useful for generally increasing the dynamic range of a signal source, and for increasing the apparent volume difference between the desired signal and the background noise which accompanies it. For situations where a more defined relationship of signal and noise is desired, the ratio may be increased to 1:10 or beyond. Such expansion ratios are normally called noise gating ratios. The slightest detected signal "gates" the expander (or noise gate) on, while noise levels do not. While such high ratios may allow more effective reduction of unwanted noise signals, a good deal of care is dictated in assuring the THRESHOLD or "switching point" is placed such that the low level portions of the desired signal are not eliminated along with the noise. With wide range/slow attacking signals such as voice, strings and the like, the use of gating ratios becomes nearly impossible, as the initial parts of signal waveforms are in the noise spectrum, and thus cannot be effectively separated. Attempts to use gating ratios on such signal sources will often result in an audible "clicking", as the normally smooth attack of the signal is abruptly "switched on".

Thus, high ratio expansion is usually used only on percussive type instruments—those which inherently have a defined attack. For other instruments, noise control is more effectively performed using lower expansion ratios such as 1:2.

B. Threshold/Attack/Release. It should be clarified that audio dynamics processing devices cannot operate instantaneously, as do conventional amplifiers. If such were the case, the processing device would become a non-linear amplifier which actually distorts the signal waveform. Obviously, we do not want waveform modification in an audio system. What is desired is to alter the envelope, rather than the individual cycles themselves. Ideally, for minimum signal distortion, the gain changes would occur very slowly, following the general "shape" of the signal

envelope, but not the actual cycles. Unfortunately, this cannot be done in practice, as a suddenly occurring energy burst in the signal source must be dealt with quickly, if any usable form of dynamics manipulation is to be realized. Thus, we have the requirement that the gain controlling mechanism respond relatively rapidly to a suddenly applied burst of input signal (such as the beat of a drum, etc.). This parameter is called the device "attack".

Once a burst of input signal has caused the device gain to quickly change (downward if compressing or limiting, upward if expanding), we must prevent further instantaneous response to prevent the gain from changing with every minute peak or dip of the waveform itself. This "tracking" would effectively cause waveform distortion. Hence, a "release" structure is required such that "return" gain changes (gain changes in the absence of input signal) are relatively slow. This is always a compromise. With certain sorts of program material, it is desirable to restore the device quickly; yet, if the gain restoration becomes too fast, distortion results. A similar compromise exists with respect to the attack structure. Both situations will be discussed in greater detail later on.

Now, we come to the question: At what point in the signal level spectrum do these gain changes occur? This point is called THRESHOLD. Let us take the example of an infinity:1 ratio limiter. Let us say that a +4dBv input signal threshold is selected, and that the device has a nominal gain of 0dB, or unity. With such parameters, the device will act as a normal unity gain amplifier as long as the input signal is lower in level than the specified +4dBv threshold. Since the device is "doing nothing" under these conditions, its ratio is 1:1. Now let us assume that an input burst measuring +10dBv suddenly appears. The limiter will "attack" in response to this over-threshold signal, reducing its gain to -6dB, thus causing the signal burst to exit the limiter at +4dBv. Had the input signal burst been +14dBv, 10dB of gain reduction would have been caused, to achieve the desired +4dBv output "clamp".

Following the input burst, the release circuitry would gently return the gain back to unity.

The definition of THRESHOLD, when applied to a limiter or compressor, then, is a signal level below which the device does nothing, and above which the device performs gain reduction according to its ratio.

For an expander or noise gate structure, the situation is reversed. In these devices the threshold is the signal level above which the device does nothing, and below which it performs gain reduction according to its ratio.

It should be noted that in both examples the attack is in response to increasing signal levels, while the release is in response to decreasing signals. Figures 1A and 1B graphically illustrate these basic parameters.

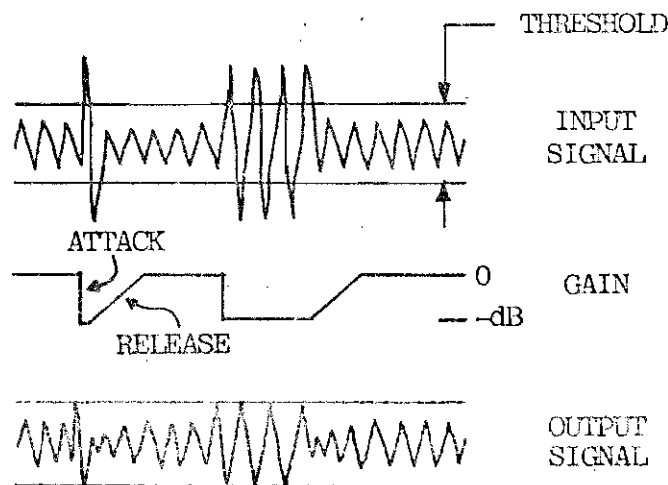

FIGURE 1A
LIMITING

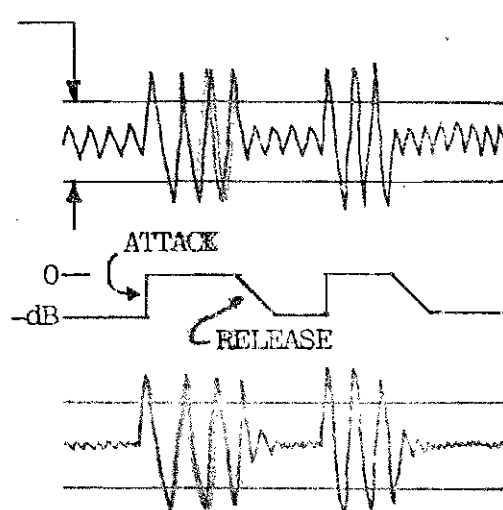

FIGURE 1B
EXPANDING

C. Detector Circuits. Several alternatives are available to the circuit designer in structuring the detector mechanism (that mechanism which measures the level fluctuations of the input signal).

At first glance, this may sound easy...just measure the voltage excursions. In fact, the graphics of Figure 1A illustrate a circuit which does just that. Such a detector is called a "peak detector", in that it measures the peak excursions, of either polarity, of the input signal. Peak detection was the backbone of early limiters which were designed for broadcast and disc cutting chains. In these peak level critical systems, the prime requirement was to prevent overloading the subsequent stages.

These detectors were required to act nearly instantaneously, on the order of $10\mu\text{s}$ to $100\mu\text{s}$, to form an absolute electrical clamp. Fast peak detection still remains the only viable method of controlling signal level to such inputs.

Unfortunately, the electrical peak value of a music waveform has little to do with how loud the sound is perceived by the human ear, due to the varying WAVEFORM COMPLEXITIES. To illustrate this point, Figure 2 plots the relative electrical and audible values for two typical music waveforms, one relatively simple, and one moderately complex. As can be seen, although the two waveforms appear at the same level of audible loudness, they exhibit completely different electrical peak values.

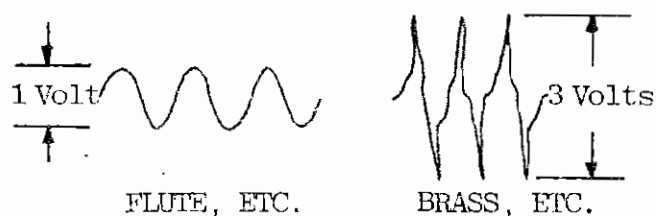

FIGURE 2

TWO TYPICAL MUSIC WAVEFORMS OF EQUAL AUDIBLE LOUDNESS.

If the two waveforms of Figure 2 were detected by a conventional fast peak detector, the brass waveform would be read as having a much higher energy level than the flute. If the detector were controlling a limiter, the audible result would be that the complex waveforms, such as brass, etc., would be "over-limited", or depressed, with respect to the simpler waveforms. This is exactly what happens in many conventional dynamics processing devices, and this is the effect most responsible for the "squashed" unnatural sound often associated with these devices. To comprehend the implications of this form of waveform discrimination, suffice it to say that the ratio of perceived audio loudness to electrical peak excursion, of various music waveforms, typically varies over a range of around 10 to 14dB.

Thus, a similar degree of variation in audible output level exists in devices which employ peak detection to self-control dynamics. The only answer to this dilemma, then, is that in situations where peak detection must be used (for the prevention of overload to critical feeds), processing must be very judiciously applied in order to maintain an acceptable degree of dynamic integrity.

In looking at most modern uses for dynamics processing equipment, it is found that the intent is not so much to control electrical peaks, rather, it is to manipulate the dynamics of the signal on the basis of *audible content*. Generally, in such uses, the equipment following the processor does not have a critical overload point, but instead has sufficient "headroom" to accept the range of complex waveforms generally found in music and speech. For instance, a typical studio level input which is designed to accept $\pm 4\text{dBv}$ signals, as measured on a VU meter, allows from 14 to 20dB of headroom for anticipated electrical peaks of

program waveforms. Numerous psycho-acoustic tests have shown that when exceedingly complex waveforms that require still more headroom appear, the inherent clipping of the extreme electrical peaks is of little audible consequence, and is to be preferred over allowing these peaks to cause gain reduction in limiter type devices.

Thus, dynamics processing equipment which is designed to perform audible-level dynamics control must employ a detection scheme which measures the audible content of the program, if it is to have any great effectiveness. While true RMS detection would at first glance appear to be ideal, there are several other factors which influence the human hearing mechanism. Not the least of these influences is the fact that in the vast majority of program sources, the most complex of waveforms are inherently produced when the performer wishes to predominate, or be heard above all else—a scream, a growling sax line, etc. It should be noted that these are the specific waveform types which most detectors discriminate against most strongly. Another factor lies in the nature of the human ear to suffer a sensitivity loss to the very high frequencies. Many of the harmonics of very complex waveforms fall into this region, thus leading to a form of waveform discrimination even with true RMS detection.

A mechanism known as LINEAR INTEGRATION DETECTION, a system pioneered by Valley People, considers all of these factors, and is employed in Dyna-Mite. Its use results in a detection scheme which is closely matched to the preferences of the human ear, and thus provides excellent dynamic integrity in the processing of audio dynamics.

D. Transient Material Response. Many music sources are of a transient nature—that is to say, they come and go quickly. In order for the human ear to perceive the presence of sonic energy, that energy must appear for a sufficient length of time for the brain to integrate it into a recognizable sound impulse. Highly transient music sources, such as drums and other percussion instruments, are characterized as having a very rapid attack/decay "spike" upon the initial impact. While the ear recognizes this sound, it does not hear it at anywhere near its true electrical power level.

If such signals are passed through limiting equipment whose attack time, or response time, is considerably faster than that of the human ear, the effect is excessive gain reduction and a loss of apparent level of the instrument. This problem is particularly bothersome with fast peak detectors.

A preferable approach, in equipment designed for apparent level control, is to allow these quick energy spikes to "overshoot" the limiting threshold, even if that overshoot causes instantaneous clipping of subsequent stages. (Many cases may be brought against allowing any quality audio signal to "clip". In this case, however, the duration of the transient overshoot is sufficiently short that the instantaneous clipping is not recognizable as distortion, and is of very little audible consequence. The alternative of incurring severe gain reduction and level loss on these transients is without question a much more bothersome and audible effect.)

In Dyna-Mite, the integration time of the detector is such that the effective attack time is in the region of 1 to 15msec, depending on signal conditions, when the device is placed in the Linear Integration Detection (AVG) mode. This time range appears optimum for the passage of such transient material within the framework of maintaining a suitable fast response to sudden energy bursts.

When Dyna-Mite is switched into the PEAK detection mode, the attack time is made considerably faster ($50\mu\text{sec}$), in order to fill the requirements of a fast peak limiter for broadcast, disc cutting and other low headroom applications.

The PEAK detection mode also finds valuable application in the expand and gating modes where the device must turn on quickly to transient material following quiet passages.

The selection of optimum detector modes, for various processing jobs, is discussed in greater detail in later chapters of this manual.

E. Release Circuit. As mentioned earlier, a controlled release must be introduced following processor attacks, in order to prevent the distortions which would otherwise be caused. In practice, it is often desirable to employ a rather fast release time, for the sake of obtaining high average levels in a limiter, or to quickly attenuate low level noise signals in an expander or noise gate. However, the use of fast release rates usually invites the gain control element to begin to follow the peaks and valleys of the waveform itself, thus producing modulation distortion. Fast release structures also encourage a situation where excess "pumping" is produced... a situation where the gain begins to follow the signal envelope too tightly.

In order to escape these ill effects, yet still allow the user to select rapid release times, Valley People has developed a proprietary circuit scheme known as ANTICIPATORY RELEASE COMPUTATION. This circuit gets its name from its inherent ability to analyze the program input and anticipate conditions which would cause either waveform gain modulation or excessively rapid pumping. When these conditions exist, a correction factor is introduced into the release circuit such as to prevent, or greatly diminish, these objectionable effects.

Unlike many previous attempts to cope with these factors via automatic circuitry, Anticipatory Release Computation provides a 5 to 10 times decrease in the effects it was designed to cure, without producing any audible slowing of the selected release rate. The employment of ARC in Dyna-Mite produces a

very audible increase in dynamic integrity, or listenability, over conventional non-compensated devices.

F. Gain Control Elements. Obviously, the heart of any dynamics processing device is the actual element which automatically alters the signal gain. In earlier devices, various elements were used for this purpose, ranging from photo-conductive cells (light dependent resistors), to FET devices, diode arrays, etc. All of these devices have parameters which are undesirable, such as audio distortion, high noise levels, non-linear control/gain relationships, etc.

Recently, Valley People introduced a voltage controlled amplifier (VCA) structure which overcomes all of these past problems. These VCAs are known as the EGC series, and have attained rapid acceptance among professional audio manufacturers for use wherever critical voltage control over signal gain is to be used. In comparison to earlier VCA types, the Valley People EGC series exhibits improvements in the noise/distortion parameters on the order of 100 to 1, thus classing it in direct comparability to the very finest of conventional fixed gain electronics. As for control/gain linearity, the EGC series offers a 160dB + range of controlled gain variation, following an extremely accurate logarithmic control response curve. Since audio signals, themselves, are logarithmic in nature, this type of VCA control response is ideal for the implementation of very high quality audio processing equipment.

2. Installation

2.1 CONNECTING DYNA-MITE TO OTHER EQUIPMENT

Dyna-Mite is configured to be connected to all commonly used audio equipment, whether balanced or unbalanced, high impedance or 600 ohm, line level or semi-pro 300mv levels. It is not intended for direct connections to microphones, or to other sources having nominal signal levels below -20dBv (100mv RMS).

Noise levels and output gain controls are such that Dyna-Mite may successfully be returned to 300mv semi-pro inputs, as well as to professional level lines, at impedances ranging from 600 ohms upward.

When connected according to the standard recommendations, Dyna-Mite should provide stable operation in all systems, including transformer coupled systems of 600 ohm minimum impedance. Dyna-Mite does not require any terminations for proper operation, nor does it, itself, provide terminations which might be required for other equipment. If Dyna-Mite is fed from a source which requires termination, it is recommended that the user consult the instructions for that equipment, and supply any terminating resistors which might be required.

Figures 3 through 9 illustrate the various configurations which are associated with the rear panel connectors, as well as detailing the recommended connections to other equipment.

While Dyna-Mite may be successfully connected to unbalanced systems via 2-circuit plugs, it is recommended that 3-circuit plugs be used, as shown, for the sake of optimum stability and freedom from ground loop induced noise.

The rear panel connectors used in Dyna-Mite are such that they will accommodate either professional (military) type plugs (2 or 3-circuit), as well as consumer type (guitar) plugs (2 or 3-circuit). (Examples: Mil. #PJ 051; Switchcraft #482 or equivalent; Switchcraft #260 or equivalent.)

Dyna-Mite is connected to the AC power line via a standard grounding (3-terminal) plug, intended for connection to conventional house wiring (105 to 125VAC, 50 to 60Hz). It is recommended, for the prevention of shock hazard, that the unit only be plugged into 3-prong grounded outlets, and that the grounding prong not be removed.

Note: If excessive hum is introduced due to the third prong ground loops, jumper J1 may be removed on the Power Supply Board. This may, however, create a shock hazard under certain extreme conditions. Valley People does not in any way recommend the removal of this jumper.

For 110VAC to 220VAC conversion, see Power Supply Parts Overlay, on page 19.

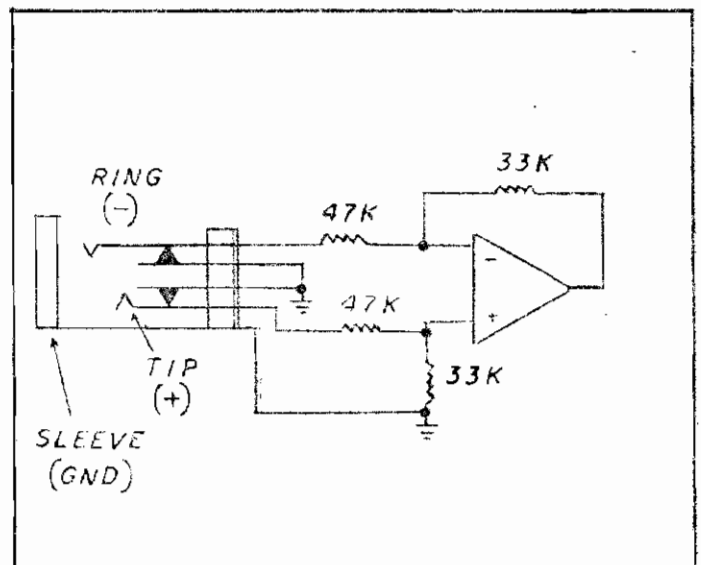

FIGURE 3
INPUT & EXT INPUT CONNECTOR CONFIGURATION
(BALANCED)

IMPEDANCE STRUCTURE

1. + INPUT TO GND: 50K
2. - INPUT TO GND: 47K
3. + INPUT TO - INPUT: 127K

MAXIMUM INPUT LEVEL:

+24dBv, RE 775V RMS

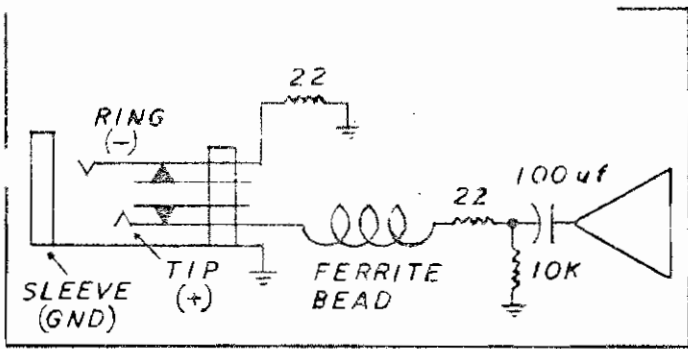

FIGURE 4

OUTPUT CONNECTOR CONFIGURATION (UNBALANCED)

IMPEDANCE STRUCTURE

1. + OUTPUT TO GND: 22 OHMS
2. - TERMINATION TO GND: 22 OHMS
3. + OUTPUT TO - TERMINATION: 44 OHMS

MAXIMUM OUTPUT LEVEL:

+21dBV RE .775V RMS INTO 600 OHMS OR HIGHER

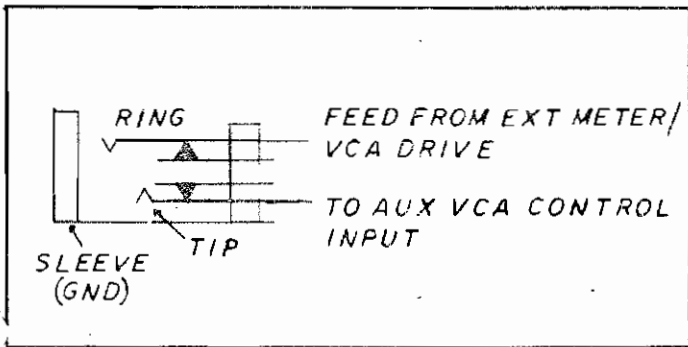

FIGURE 5

CONTROL/METER CONNECTOR CONFIGURATION (TWO CIRCUIT - UNBALANCED)

SCALING (BOTH CIRCUITS): -20dB/+ VOLT IMPEDANCE

1. FEED: 47 OHMS (10ma MAX CURRENT)
2. INPUT: 4K OHMS

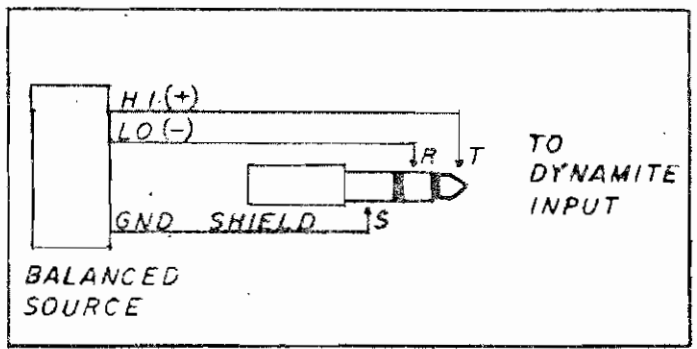

FIGURE 7

RECOMMENDED CONNECTION WHEN FEEDING DYNAMITE FROM A BALANCED SOURCE

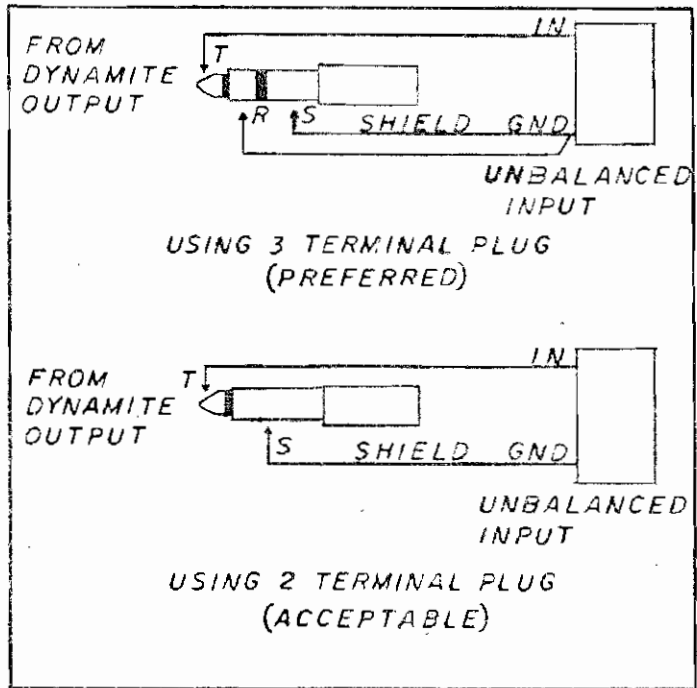

FIGURE 8

RECOMMENDED CONNECTIONS FOR FEEDING AN UNBALANCED INPUT FROM DYNAMITE OUTPUT

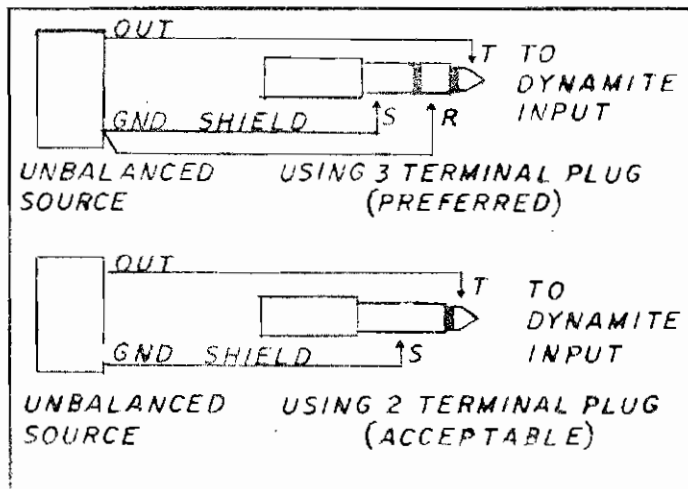

FIGURE 6

RECOMMENDED CONNECTIONS WHEN FEEDING DYNAMITE FROM UNBALANCED SOURCES

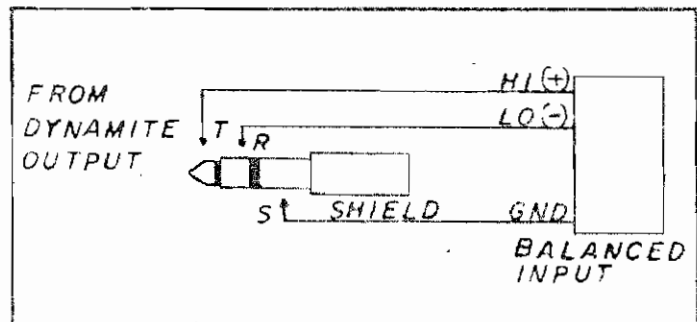

FIGURE 9

RECOMMENDED CONNECTION FOR FEEDING A BALANCED INPUT FROM DYNAMITE OUTPUT

2.2 ACCESSORIES

Dyna-Mite may be ordered as a 1-channel, or Mono Unit—Model #410-1.

Dyna-Mite may be ordered as a 2-channel, or Stereo Unit—Model #410-2.

A single Dyna-Mite Channel may be ordered to upgrade a mono unit to a stereo unit—Model #410-C.

A rack-mount "shelf" may be ordered as Model #400-R. It will mount one or two Dyna-Mite units.

For external powering, an external power connector is required and may be ordered as Model #400-EPC.

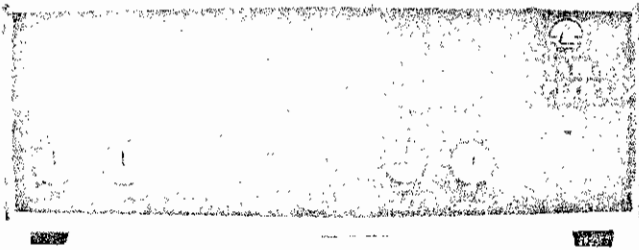

Mono DYNA-MITE, Model #410-1

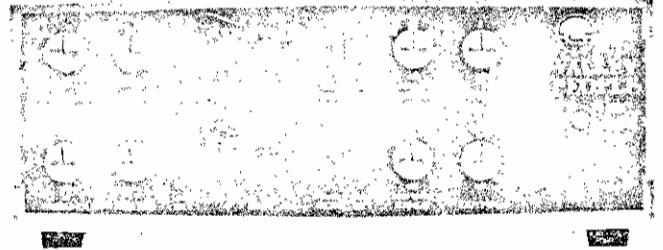

Stereo (2 channel) DYNA-MITE, Model #410-2

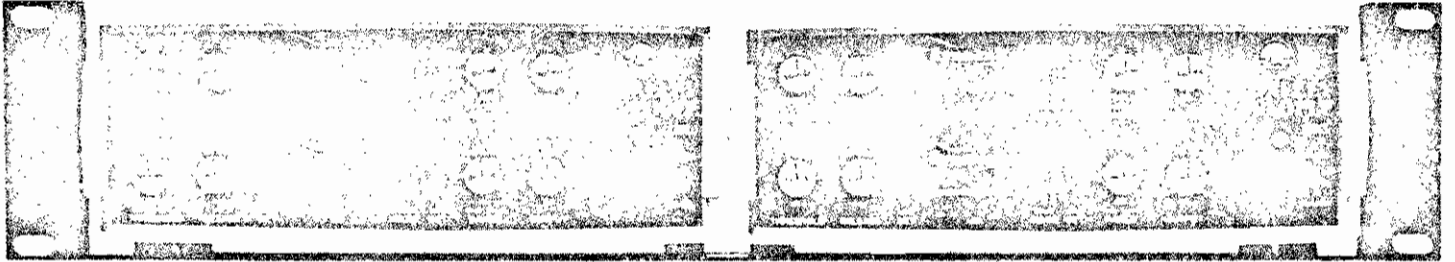

Two Stereo DYNA-MITE units mounted in a Model #400-R Rack Shelf. Note: A single unit may also be mounted alone.

3. Theory of Operation

3.1 BLOCK DIAGRAM

Essentially all audio dynamics processing functions involve three elements: a detector circuit, a release circuit, and a VCA.

Once these elements are present, the various processing functions may be configured by various electronic manipulations to the detected control signal. With the advent of quality VCAs such as the EGC series, the highly accurate logarithmic control/gain

relationship allows a much greater precision in the synthesis of these various functions. It is the combination of these advanced technologies which have allowed the configuration of the Valley People Dyna-Mite as an exceedingly effective multi-function dynamics processing device.

Using the block diagram of Figure 10 as a reference, let us conduct a study of these functions, how they are accomplished, and what their parameters are.

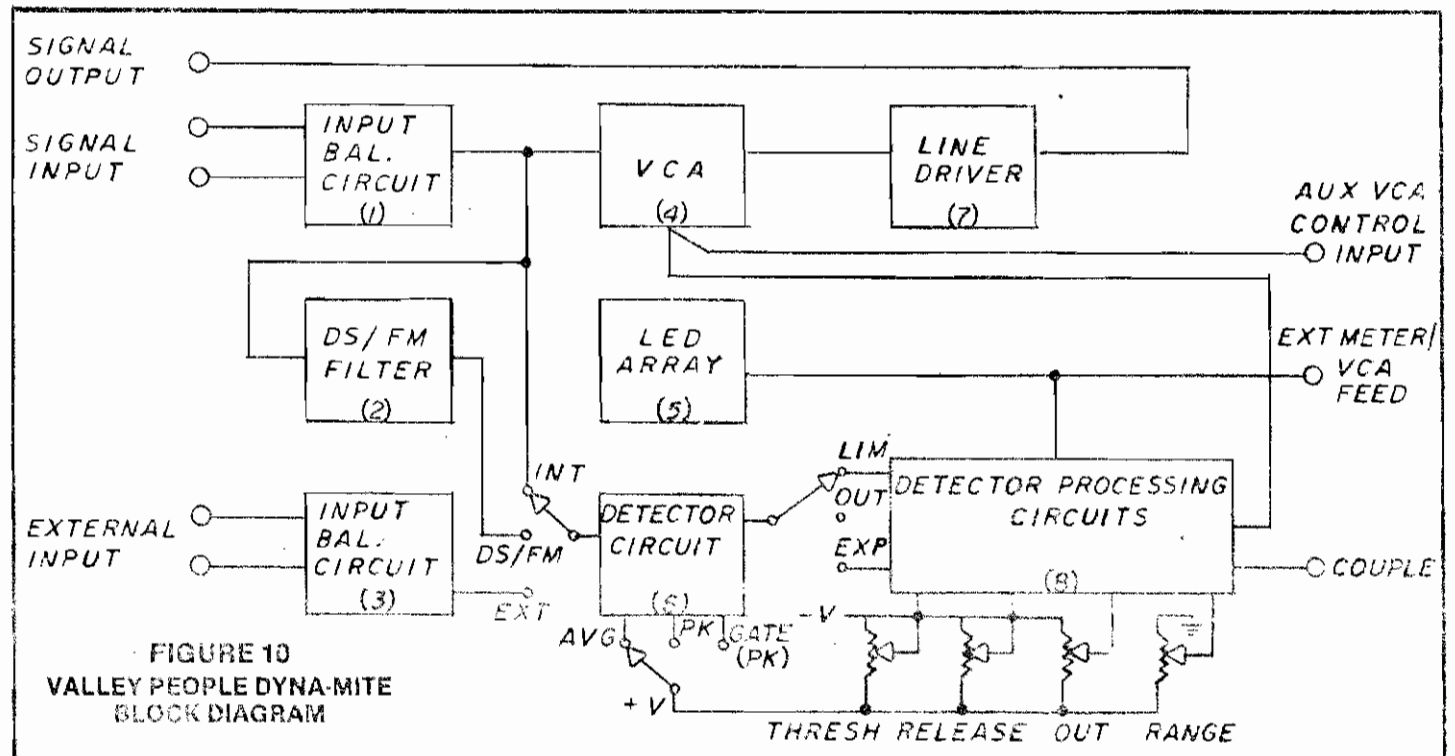

FIGURE 10
VALLEY PEOPLE DYNA-MITE
BLOCK DIAGRAM

3.2 CIRCUIT DESCRIPTION

It is seen that the audio signal path consists only of an input balancing amplifier (1), the VCA (4), and the output line driving stage (7). The input stage is configured such that it may accept signal levels up to +24dBv, from either balanced or unbalanced sources, at a bridging impedance of 47K minimum. The noise levels are such that a direct connection may be made to relatively low level semi-pro sources, as well as professional +4dBm or +8dBm lines. The output stage is configured to drive load impedances or transformers of 600 ohms or higher, to a maximum level of +21dBv. Again, direct output connections may be made to low level semi-pro equipment, while maintaining excellent signal to noise ratios, as well as connections to professional standard +4dBm or +8dBm lines. As can be imagined, this feedforward VCA structure is optimum for the preservation of audio signal fidelity, due to the minimal circuitry in the audio path. It is also optimal for the synthesis of a variety of processing functions, when the VCA employed has the extreme gain control range and precision exhibited by the Valley People EGC series.

Now, in looking at the detector, or "side chain" path, it is seen that signals may be directed to the detector either from the main audio feed (1), or from the similarly structured external audio input stage (3). In other words, the gain controlling signals fed to the VCA control inputs may be either self-generated (int), or generated by a second audio signal (ext). It is also seen that the main audio feed may be directed through the FM/DS filter, before passing to the detector. It should be noted that in this configuration only the detector is fed an equalized signal. The signal passing through the VCA to the output is unequalized.

The detector circuits (Block 6) perform the function of converting the incoming audio signals into either the log-of-the-average-of-the-absolute-values (Linear Integration Detection, AVG position), or into the log-of-the-absolute-value (PEAK position). The same switch which determines the type of detection also determines whether the signal level/gain change ratio will be low (for 1:2 expansion, or infinity:1 limiting), or high (for 1:20 noise gating and keying, or for 1: -20, negative limiting, ducking and keying off effects). It should be noted that these high ratios are created with the switch in GATE position, and that use of this position dictates that the detection type is PEAK.

The third switch determines whether the characteristics of the device will be that of a limiter (signals above threshold cause gain reduction), or that of an expander (signals below threshold cause gain reduction), or signals cause no effect on gain (out position).

In the detector processing circuit block (8), the parameters of Threshold, Release Time, Gain Control Range and Output Gain are computed from the voltages produced by the corresponding front panel controls. It should be noted that since the detected signals are now in log form, that the use of linear taper control potentiometers, in a voltage producing format, may be used. The result, as compared to older circuits employing log taper non-voltage-producing pots, is a dramatic increase in precision and range of control, as well as a superior conformity to the scale markings on the panel.

The conditioned control signals exiting the detector processing circuits (8) are then fed to the control terminal of the VCA block (4), and to the LED Gain Reduction Display (5), where the amount of gain reduction is visually monitored. There is also a feed to drive an externally mounted VCA, or auxiliary metering devices. This drive provides +1 volt DC per 20dB of directed gain reduction, and appears on the "ring" terminal of the rear panel connector marked "Control/Meter". The "tip" of this same connector is capable of receiving an external control voltage from another source and feeding it to an auxiliary control input of the onboard VCA, so as to provide voltage controlled gain/loss from another source (tremolo oscillator, etc.). The control/gain scaling at this external VCA control input is also +1 volt DC per 20dB of attenuation (or -1 volt DC per 20dB of gain increase). This log responsive VCA control input responds on a linear db/volt relationship. That is to say, that for each increment of control

voltage which is applied, a given number of DB of gain change will result, regardless of the absolute value of VCA gain (within its gain control range). The gain control range of the EGC VCA employed in Dyna-Mite is approximately 160dB (from -100dB to +60dB). Thus, the application of additional external control voltages to the VCA (via the tip of the Control/Meter connector) will result in gain change at the specified (-20dB/volt, independent of any gain control supplied to the VCA by the internal circuits. As an example, the application of a low frequency oscillator at a peak to peak voltage of 2 volts (to the external VCA control input) will result in low frequency tremolo in which the audio gain increases by 20dB on the negative oscillator swings, and decreases by 20dB on the positive swings.

In a final observation, it is seen that a line extends from Block 8, which is labeled "Couple". This line goes to the front panel Couple switch. When this switch is pressed (on a stereo Dyna-Mite unit), the two modules are intercoupled for stereo center image preservation. When either unit attacks and releases, the other unit is caused to follow. This coupling is non-additive; that is, if both units attack, double gain changes do not occur. . . both units follow the higher of the two gain changes, as is needed for maintaining accurate center image.

The Range Control. This control serves to place a controllable limit upon the maximum amount of gain reduction which may be generated within the Dyna-Mite. For operator convenience, the RANGE control is out of the circuit in certain operating modes. Specifically, the RANGE control is ineffective during normal internal limiting and DS modes. In these modes, the maximum gain reduction range is fixed at 60dB. In all other modes, maximum gain reduction may be set anywhere between 0dB and 60dB with the RANGE control.

Threshold/VCA Gain Coupling. In those *internal* limit and DS modes in which the range control is ineffective, a voltage controlled coupling connection is made between the THRESHOLD control and the VCA output gain. The purpose of this coupling is to allow the user an easier operation in these much used modes.

In most limiter devices, manipulation of the THRESHOLD control to a lower threshold of limiting causes more limiting to occur. Because of the increased gain reduction, the output level drops accordingly. It is thus necessary for the operator to re-adjust the output level control each time an adjustment is made to the threshold of limiting. This situation, in addition to being rather cumbersome, makes it a difficult matter to alter the amount of limiting of a program during a live take, due to the probability of a shift in output level during the operation.

When Dyna-Mite is set up as a conventional limiter/de-esser, the output level is automatically adjusted, via the THRESHOLD/VCA GAIN COUPLING circuit, in such a manner as to maintain a fixed and constant output level during limiting, regardless of the position of the THRESHOLD control. Thus, if more limiting is desired, even during a live take, the operator need only lower the THRESHOLD control. The output level will be maintained.

A further simplification of operation in these modes is afforded by the structure of the OUTPUT control. When performing conventional limit/DS functions, the calibrations on the OUTPUT control correspond directly to the dBv output level which will occur during limiting. Thus, if the device is feeding a +4dBv studio tape machine, the operator need simply set the OUTPUT control to +4, and this output level will be produced whenever the device is limiting.

It should be noted here that a standard VU meter is an average responding device. Thus, if limiting is performed with the AVG detection selected, the calibrations on the OUTPUT control will provide the exact readings on a VU meter. However, if PEAK detection is selected, the calibrations on the OUTPUT control will correspond to the PEAK excursions of the output signal. If a VU meter is used for monitoring in the PEAK detection mode, the meter readings will be much lower (5 to 8dB) than indicated on the OUTPUT control calibrations, due to the waveform complexities involved. If the user were to substitute a sine wave

source in place of a music input, he would find that the calibrations then concur with the meter reading.

An interesting lesson can be learned by the operator, with respect to the effectiveness of the Linear Integration Detection scheme, when the device is configured as a limiter. The following experiment is suggested:

1. Input a 1KHz sine wave tone.
2. With the detector switch in PEAK position, adjust the THRESHOLD control such that around 10dB of limiting is being indicated on the gain reduction LED array.
3. Adjust the OUTPUT control such that a 0dB reading shows on a VU meter connected to the device output. (A console buss meter may be used.)
4. Now switch the detector switch to AVG position (Linear Integration Detection). You should see no significant change in the amount of limiting, or in the VU meter reading. This verifies

that the threshold of limiting for a sine wave is the same for either detector setting.

5. Now, substitute various music sources to the input, instead of the test oscillator. If you now observe the VU meter reading, you should find that in the AVG detector mode, the output level during limiting remains at or near "0", as it did for the sine wave. Only on highly transient material, such as drums, should you find a significantly lower output level, due to the relatively slow ballistics of the VU meter movement. If you now switch to the PEAK detector mode, you will find the observed output level to be probably 5 to 10dB lower than for the sine wave, and quite dependent upon the specific music source. A flute will output a higher level, for instance, than will a sax.

What you are seeing is the waveform discrimination effect of the conventional PEAK detection method, and the obviously superior performance of the Linear Integration Detection method.

4. Operating Instructions

4.1 THE CONTROLS

Limit/Out/Expand Switch. Establishes the most fundamental modes. LIMIT equates to gain reduction caused by signals increasing above Threshold, while in EXPAND, gain reduction occurs when signals decrease below Threshold. The Limiting Ratio or Expansion Ratio is determined by the...

Peak/AVG/Gate Switch. Besides establishing LIMIT/EXPAND RATIOS, this switch sets the detector to respond as a conventional fast peak detector, or as an averaging Linear Integration Detector. When set to either the PEAK or AVG positions, the LIMIT/EXPAND RATIOS are, respectively, Infinity:1 and 1:2. Thus, if the first switch were set to "LIMIT", while the second switch were set to "PEAK", a relatively conventional peak limiter would result, having a Limiting Ratio of Inf:1.

In the GATE position, fast peak detection is exhibited, but the LIMIT/EXPAND RATIOS are increased to 1:-20 (negative limiting or "ducking") and 1:20 (high ratio gating or "keying"). Example: if "EXPAND" and "GATE" were selected, a noise gate structure would result wherein signals 1dB below Threshold are attenuated by 20dB, etc.

It should be noted that in EXPAND, the Attack is upward, in terms of gain, while the Release is downward. The converse is true in LIMIT. Thus, in noise gating use, the sudden application of a signal (such as a drum beat) essentially instantaneously turns the gain fully on, thus "catching" the instrument. When the signal ceases, the gain is reduced at a much slower rate, as governed by the Release Time.

Internal/DS-FM/External Switch. Determines the source of the signal which is fed to the detector. In INTERNAL position, the actual audio input signal is connected to the detector, thus forming the conventional connection for limiting or expanding—the signal controls itself.

In the DS-FM position, the input signal is passed through an equalizer circuit having 6dB/octave boost above 2KHz (75µsec curve). Thus, the effective Threshold decreases (increased sensitivity) for the higher frequencies, even though the actual audio signal is passed through the VCA without equalization. Besides being a requisite to proper FM broadcast use, this characteristic produces excellent de-essing action (particularly in conjunction with the AVG detector setting). It is also helpful in the Gating and Expanding modes when increased sensitivity to high frequencies is desirable.

In the EXTERNAL position, the detector is not connected to the input signal at all, but is routed to a rear panel jack marked EXT INPUT. Thus, gain control is not a function of the input signal passing through the VCA, but is determined by a second signal which may, or may not, be related to the input signal. This forms the basic connection for Keying and Ducking effects. As an

example, assume that the three switches are set to "LIMIT", "GATE" and "EXT", and that music is applied to the SIGNAL INPUT, while narration is applied to the EXT INPUT. According to earlier statements, a "DUCKING" ratio of 1:-20 is established, but because of the EXT position of the last switch, this gain reduction will not be incurred by INPUT SIGNAL excursions (music) but, rather, will result from EXT SIGNAL excursions (narration).

Thus, whenever the narrator's voice level exceeds the Threshold setting, 20dB of gain reduction will result for each 1dB by which the narrator signal exceeds the Threshold setting. In effect, with proper setting of the Threshold, each time the narrator speaks, the gain (volume) of the music would be completely shut off, were it not for the...

Range Control. This control places a limit upon the maximum gain reduction which can occur in the EXPAND, DUCK and GATE modes. It varies from 0dB (no gain reduction) to 60dB POSSIBLE GAIN REDUCTION. Were this control set to, say, 15dB in the above example, the music would be gain reduced or "ducked" by exactly 15dB each time the narrator spoke. Nominal gain would then be restored at a rate determined by the Release Time, when the narrator became silent. A similarly effective control over maximum gain reduction results when Gating, Keying and Expanding. (In order to clarify the terminology, the term "Gating" normally applies when the signal "turns itself on", as in "noise gating", while "keying" usually indicates that a second signal is being used to key the input signal on, via the EXT input.)

Threshold Control. Determines the signal level above which Limiting action commences, or below which Expanding action begins. Also serves as the effective switching point for Gating, Ducking and Keying. Variable from -40dBv to +20dBv.

Release Time Control. Determines the rate at which gain is restored after Limiting or Ducking, as well as the rate at which gain is reduced after Gating, Keying or Expansion attacks. Variable from 50ms to 5sec./20dB.

Output Level/Gain Control. Determines either the VCA nominal gain, or the device output level, dependent upon the modes selected. In the Limit and De-ess modes, the desired output level (in dBv) is dialed on this control. By means of coupling between the Threshold Control and the VCA, this predetermined output level is maintained regardless of the amount of limiting. The amount of limiting is determined solely by operating the Threshold. Thus, setting up for limiting becomes exceedingly simple: Dial the desired output level (i.e., +4dBv to feed a studio tape machine), then rotate the Threshold Control for a suitable amount of limiting. Once set, the Output Level need not be readjusted for different Thresholds.

undesired "ess" sounds. With Linear Integration Detection, the natural action is to pass the desired vocal transients, while attenuating the "ess" waveforms.

To set up for De-essing, Dyna-Mite should be configured the same as for #1, with the exception that Switch 1 should be placed in the FM/DS position, rather than INT.

Use. Once set up, Dyna-Mite should be used as a conventional limiter for vocals. If the user desires to verify the DS action, it is only necessary to switch back and forth between FM/DS and INT, to hear the difference. The De-essing action thus obtained should prove very satisfactory for most uses. It is, however, possible to obtain a more controllable DS action, for critical applications, by using the EXT position of Switch 1, and patching an external tunable filter network such that it receives signal from the main signal input, and feeds the external signal input.

It should be remembered that, when using the EXT limiting function, the RANGE control is in the circuit, while the THRESHOLD/GAIN coupling feature is disconnected. Thus, it may be necessary to re-adjust the OUTPUT control whenever THRESHOLD adjustments are made. If a maximum amount of gain reduction is to be established with this configuration, the RANGE control may be adjusted to establish that maximum.

B. EXPANDING FUNCTIONS

5. General Noise Reduction via 1:2 Expansion. It is often desirable, especially when processing individual tracks, to configure Dyna-Mite to gently attenuate undesirable low level signals such as tape noise, room noise, amplifier noise, leakage, etc. In such applications, the relatively gentle 1:2 expansion characteristics are often preferred over the higher "gating" ratios. In such general applications, the use of high gating ratios often results in an overly defined "switching point", which can lead to an audible sensation that the signal is being switched off and on. When using the 1:2 ratio expansion, the setting of the THRESHOLD control determines which signal levels will be passed at a pre-selected gain (by output control). Thus, signals above the THRESHOLD setting will "turn on" the device to its pre-selected gain, and be passed without modification. When signal levels fall below THRESHOLD, they are considered as "noise" signals, and are attenuated according to how far below threshold they are. For example, if a signal appears which is 3dB below THRESHOLD, the 1:2 expansion action will cause 3dB of gain reduction; thus, the same signal will exit the Dyna-Mite at an attenuation of 3dB. Should the signal appear at a level 20dB below THRESHOLD, 20dB of gain reduction will occur. This relatively gentle action allows for a gradual transition of gain changes about the THRESHOLD point, and is usually necessary for the unobtrusive processing of wide range program material which is devoid of defined off and on states. Typical among such sources are vocal signals, strings, horns and other non-percussive instruments.

There is also the situation of attack time to consider, when performing noise reduction. It must be remembered that, in periods of non-signal, the device gain will be reduced. When signal passages appear, the gain must be restored at a rate suitable to prevent the loss of the initial portions of the applied signal. If the signal to be processed inherently exhibits a slow attack (voice, strings, etc.), the use of the AVG detection mode may be indicated... may sound smoother. If the inherent instrument attack is moderate to fast, it will be necessary to use the PEAK detection mode to insure that the initial impulse fully restores the gain. It should be noted here that the 50 μ sec attack time evident in the PEAK mode is adequately fast to insure full turn on to the most highly transient material the ear is capable of hearing.

In performing noise reduction, it is also sometimes desirable to place a limit upon the maximum amount of gain reduction which may occur during non-signal passages. Allowing the gain to be reduced by the full 60dB available may, in some situations, cause an audible sense that the background noise is going off and on. This effect is often more undesirable than the noise itself. Thus, by adjusting the RANGE control, the "off" gain may be

set to the most audibly pleasing point.

Operating the RELEASE TIME will also have a profound effect on the subjective quality of the noise reduction action. If very fast release settings are used, maximal effective attenuation of noise signals will result, but at the cost of a greater sensation that the device is altering the gain relationships. Longer release times will result in less obtrusive operation, but less dramatic results. The optimum release is entirely dictated by "ear", according to the specifics of the material being processed, and the desired results.

It should be interjected that when performing noise reduction on individual tracks of a multi-track program, the gain alteration effects may be quite discernable when the processed track is "soloed", yet may be completely non-objectionable when the track is mixed in context with the rest of the program. It is wise to be conscious of this, and not be so concerned about what a track sounds like by itself, rather, the decisions should be made based on the effect on the overall program. Remember, a 24-track mix consists of 24 sets of noise sources. The accumulation of these noise sources can add up to one very noisy combination in the final mix. By attenuating these noise sources on an individual basis—before the mix, an astonishing increase in signal to noise contrast can result. Attempts to deal with the accumulation of noise sources after the mix are, at best, very marginal.

Armed with this background information on noise reduction, let us proceed to a typical beginning setup.

Procedure: Insert the Dyna-Mite into the signal path to be noise reduced, using the normal signal input and output termination. Set the front panel switches as follows: (1) INT; (2) EXP; (3) PEAK (AVG if dealing with slow attack instruments... experiment). Begin with the RELEASE TIME control set to its fastest setting (CCW), with the RANGE control set to 60dB (CCW). Set the OUTPUT control to "0", unless gains other than unity are desired under signal-present-conditions.

Adjust THRESHOLD such that the desired portions of the input signal cause the gain reduction LED array to indicate maximum gain (all LEDs extinguished), while the undesired noise signals cause gain reduction. At this point, the device will be very "active", due to the short release and wide range. The audible effect will be very severe and noticeable. You should now begin to make adjustments to the RELEASE TIME and RANGE, as required to obtain the desired amount of noise reduction, consistent with maintaining a suitably "unprocessed" sound. These parametric decisions are highly subjective, and dependent on the signal source, as well as dependent on the user's interpretation of what is "desirable sound". Don't be afraid to experiment. As stated before, it is desirable to listen to the program both by itself, and in context with the remaining tracks.

For general use, to attenuate tape noise in "dead" passages, a quite reliable result can be expected by pre-selecting parameters as follows: RELEASE: moderate to long; THRESHOLD: about 20dB below anticipated nominal signal level; RANGE: about 30dB; DETECTOR: PEAK.

With this "pre-set", it can be expected that the device will reliably reproduce all signals coming from the tape, while providing good reduction of tape background noise during dead passages. If the dead passages contain a good deal of other noise, such as leakage, hum, etc., more critical settings may be required for optimum results.

6. Noise Gating—For Percussive and Defined Signal Sources. There are certain situations where a more defined noise gating action is to be preferred, with respect to that action obtained by the setup of #5, above. Typical among these uses, are those situations where the desired signal has a defined attack level, and where radical processing is desired. A good example of these conditions would be found in a bass drum track, which also contains undesirable leakage from other sources. By selecting the GATE position of Switch 2, the device may be made to very sharply "turn on" to the bass drum impact signal, while definably remaining at high attenuation during other times. By adjusting

the RELEASE TIME, the effective "after-ring" of the drum signal may be shortened, if desired, thus turning a "loose, ringy" drum sound into a highly dampened, more defined effect. In other examples, a track containing, say, handclaps amid room leakage and reverberation may be dealt with in such a manner as to reproduce the handclaps cleanly, while completely removing the extraneous room sounds. The results in this sort of usage are exceedingly satisfying, given proper "by ear" manipulation of the THRESHOLD and RELEASE controls.

Please note that when the GATE position of Switch 3 is selected, the detection method is inherently PEAK; thus, the device will instantaneously "turn on" to applied signal transients. It should also be noted that in the GATE/EXP setting, the ratio is 1:20, causing signals only 2dB below the selected threshold to be attenuated by 40dB. Thus, the setting of the THRESHOLD control becomes rather critical, lest desired signals which are somewhat low in level be ignored, and considered as noise. These attributes, while being critical to the processing of wide range signals, are of great benefit in situations where it is desired to "pick-off-the-top" of applied signals. For instance, it is possible to process a drum track in such a fashion as to reproduce the snare drum, while essentially removing the cymbals, by careful setting. By adjusting the RANGE control in such situations, it is also possible, rather than to remove the cymbals, to reduce them by any desired degree between 0dB and 60dB. In general, try the noise gating mode in all percussive instrument situations where problems exist in the areas of excess room leakage and reverberation. In this manner, sounds which were previously "loose" or "ringy" may be effectively "sharpened" or "tightened".

For all the effects described in this section, the following switch positions should be used: (1) INT; (2) EXP; (3) GATE.

7. Noise Gating or Noise Expanding, Using the FM/DS Filter. If it is desired to perform gating or expanding as described in #5 and #6, with an increased threshold sensitivity to the higher frequencies, the first switch may be placed in the DS/FM POSITION. This configuration may prove particularly useful in the gating modes, when the desired signal to be passed is a delicate high frequency percussion instrument, such as a tambourine.

8. Noise Gating or Expanding, Using an External Equalizer. It is possible to still further tailor the frequency response of the threshold detection circuitry by using the EXT position of Switch 1, and bridging the input signal with an outboard equalizer, then feeding the equalizer output to the rear panel EXTERNAL INPUT connector. In this manner, the side chain detector receives an equalized signal, while the main audio path remains unequalized. In this manner, frequencies in the range of the desired signal may be boosted in the equalizer, thus providing a more reliable turn on, while providing less turn on sensitivity to the undesired noise signals.

C. KEYING, DUCKING AND ENVELOPE FOLLOWING

9. Keying Effects. Many effects are possible if Dyna-Mite is configured such that the presence of one signal source causes a second signal source to be turned on. For instance, a piano track may be made to turn on in the mix each time the bass drum strikes, thus creating a "piano/drum". Another example might be where a number of background vocal tracks are supposed to come in tightly on cue, but where that cue is poorly performed on some tracks. Here, one track which has proper cue timing may be used to "key on" the remaining tracks, thus causing the proper cue timing.

These effects are performed by feeding the signal to be gain controlled into the normal signal input, for passage through the YCA to the output. The second signal, which is to cause gain changes in the first, is connected to the EXTERNAL SIGNAL INPUT. When the first switch is placed in the EXT position, the second signal will be detected, and cause gain changes to the first signal. The second signal, itself, is not heard in the output—only its effect on the gain of the first signal.

For our purposes here, "KEYING" is used to define a condition where the presence of an external signal *turns on* the

main signal. The complimentary action—where the presence of an external signal *turns off* the main signal—is called "DUCKING", and is described in #11.

Setup for Keying. To perform the KEYING effects, as defined above, the signal to be gain controlled is connected to the INPUT connector, while the gain controlling signal is connected to the EXTERNAL INPUT connector. The front panel switches are then set as follows: (1) EXT; (2) EXP; (3) GATE.

It should be noted that with Switch 3 in the GATE position, the turn on response to the external signal will be essentially instantaneous, and related to its PEAK value. The ratios are such that 20dB of gain reduction will occur for each 1dB by which the external signal falls below the THRESHOLD setting. Thus, a defined turn on of gain will result each time the external signal level reaches threshold. An equally defined turn off will result whenever the external signal falls below threshold. The turn off, however, will not be instantaneous, but will occur at whatever rate is selected by the RELEASE TIME control.

How far "off" the gain goes, in the absence of external signals, is a function of the RANGE control, and may be adjusted anywhere between 0dB and 60dB, as desired. The OUTPUT control serves as a simple overall gain control.

In setting up for a KEYING effect, one would normally start by setting the RELEASE to its fastest position (CCW), the RANGE to its maximum (CCW), then adjusting the THRESHOLD control (with both sources playing), such that the main signal reliably turns on to the desired portions of the external keying signal. The operator would then adjust the RANGE and RELEASE controls to produce the desired "off depth" and turn off rate, respectively.

10. Envelope Following. This effect is the same as described above in #9, except that the gain of the main signal is caused to *follow* the level of the external signal, on a dB/dB basis, rather than being effectively switched off and on. The setup is exactly the same, except that Switch 3 is placed either in PEAK (for fast attack peak following), or in AVG (for slower attack following of the average level of the external signal).

The result of these configurations is a much "softer" keying effect than when the third switch is placed in the GATE position.

11. Ducking Effects. In contrast to the KEYING effects, the Dyna-Mite may be set to cause the gain of the main signal to be turned *off* in the presence of a second external signal. A typical use for this mode would be found when a disc jockey "talks over" the music program. By routing the DJ's microphone to the EXTERNAL INPUT, the presence of his voice can be made to turn off, or attenuate, the gain of the main signal path. If the program music is connected to the normal signal INPUT, the music will be "DUCKED" each time the DJ talks.

As with operation in the KEYING mode, the maximum attenuation of the INPUT signal may be adjusted by operating the RANGE control, while the rate of recovery, following a "DUCK" is determined by the setting of the RELEASE control. Thus, the depth of the DUCK can be set anywhere between 0dB and 60dB, and the return of signal gain is variable in rate.

Setup for Ducking. For performing DUCKING operations, the two signals should be connected as described above. The front panel switches should then be set as follows: (1) EXT; (2) LIMIT; (3) GATE.

It should be noted that with Switch 3 in GATE position, the turn on response is essentially instantaneous, and governed by the PEAK value of the applied external signal. The ratio is such that 20dB of main signal gain reduction will be incurred for each 1dB by which the external signal exceeds the indicated threshold. Thus, essentially a switching action is developed, causing a defined DUCK whenever the external signal exceeds threshold, and a defined recovery when the external signal falls below threshold. The actual amount of gain reduction, of course, is determined by the setting of the RANGE control.

In setting up for a DUCKING operation, one would normally start with the RANGE at maximum (CCW), the RELEASE

TIME at minimum (CCW), and the THRESHOLD at maximum (CW). After applying both signal sources, the THRESHOLD would be adjusted such that a reliable full DUCK were achieved on each external signal passage. The operator would then adjust the RANGE control for the desired depth of DUCK, and the RELEASE control for the desired recovery rate.

12. Inverse Envelope Following. This effect is similar to that described above in #11, except the gain of the main INPUT signal is made to inversely follow the level of the applied EXTERNAL INPUT signal, rather than to be switched by it.

The setup is exactly the same, except that Switch 3 is placed in either the PEAK position (for fast attack peak inverse following), or in AVG (for slower attack inverse following of the average value of the external signal level).

The result of these configurations is a much softer form of DUCKING than that obtained in #11 above.

13. Range Controlled Negative Limiting. In one final operating mode, Dyna-Mite may be configured to perform the relatively uncommon function of a negative limiter. What happens here is that, as the input signal reaches the threshold of limiting, the gain abruptly decreases in response to further signal level increases. The NEGATIVE LIMITING ratio of 1:-20 is

such that a 1dB increase in signal level over threshold will attempt to cause 20dB of gain attenuation. (The actual amount of gain reduction is determined by the RANGE control, and may be set anywhere between 6dB and 60dB.)

As can be imagined, the net effect of NEGATIVE LIMITING is that once the input signal reaches threshold, further increases are met by a radically declining output level. The mode can find usefulness in the creation of organ-like effects (slow attack) from signal sources which normally have a fast attack. As an example, if an electric guitar is used as a signal source, the threshold may be adjusted such that the guitar's attack impulse just barely exceeds threshold, thus quickly shutting down the gain to whatever amount is established by the RANGE control. Following this initial attack, and at a rate determined by the setting of the RELEASE control, the device will recover to its normal gain, thus gradually bringing up the guitar sound, in an organ-like fashion. Experimentation with various settings and music sources will yield some interesting results.

The setup for NEGATIVE LIMITING effects is the same as described in #1 for general apparent level control, with the exception that the third switch is placed in the GATE position. Under this setup, the OUTPUT control becomes a simple gain control.

SWITCH SETTINGS				BASIC USE AREAS	PARAMETERS
S1 (DET)	S2 (MODE)	S3 (DET)			
1.	-	OUT	-	Bypass	Fixed gain... OUTPUT control active.
2.	INT	LIM	AVG	Apparent Level Limiting	Ratio = Inf:1, AVG detection of input signal, RANGE control inactive. See THRESHOLD/OUTPUT GAIN COUPLING*.
3.	INT	LIM	PEAK	Electrical Peak Limiting	Same as above, except PEAK detection of input signal.
4.	INT	LIM	GATE	Negative Limiting for "Organ Effects"	RATIO = 1:-20, PEAK detection of input signal, RANGE control active. As input signal exceeds THRESHOLD, a 1dB increase causes a 20dB decrease in output level.
5.	DS-FM	LIM	AVG	De-essing, FM Limiting	Same as #2, except Hi Freq EQ inserted in detector path.
6.	DS-FM	LIM	PEAK	De-essing, FM Limiting	Same as #3, except Hi Freq EQ inserted in detector path.
7.	DS-FM	LIM	GATE	Modified Negative Limiting	Same as #4, except Hi Freq EQ inserted in detector path.
8.	EXT	LIM	AVG	Inverse Envelope Follower, or "Soft Ducking"	Signal gain is determined by LEVEL of EXTERNAL SIGNAL. A 1dB increase of EXT SIGNAL (over THRESHOLD) causes a 1dB decrease in signal gain. AVG detection, RANGE active.
9.	EXT	LIM	PEAK	Inverse Envelope Follower	Same as above, except PEAK detection.
10.	EXT	LIM	GATE	Hard Ducking	A 1dB increase of EXTERNAL SIGNAL LEVEL (over THRESHOLD) causes a 20dB decrease in signal gain. PEAK detection, RANGE control active.
11.	INT	EXP	AVG	Expanding, Soft Noise Gating	Ratio = 1:2, AVG detection of input signal, RANGE control active.
12.	INT	EXP	PEAK	Expanding, Soft Noise Gating	Same as above, except PEAK detection.
13.	INT	EXP	GATE	Hard Noise Gating	RATIO = 1:20, PEAK detection of input signal, RANGE control active.
14.	DS-FM	EXP	AVG	Freq Selective Expansion	Same as #11, except Hi Freq EQ inserted in detector path.
15.	DS-FM	EXP	PEAK	Freq Selective Expansion	Same as #12, except Hi Freq EQ inserted in detector path.
16.	DS-FM	EXP	GATE	Freq Selective Noise Gating	Same as #13, except Hi Freq EQ inserted in detector path.
17.	EXT	EXP	AVG	Envelope Following Soft Keying	Signal gain is determined by LEVEL of EXTERNAL SIGNAL. A 1dB increase of EXT SIGNAL (over THRESHOLD) causes a 1dB increase in signal gain. AVG detection, RANGE control active.
18.	EXT	EXP	PEAK	Envelope Following Soft Keying	Same as above, except PEAK detection.
19.	EXT	EXP	GATE	Hard Keying	Signal gain is determined by LEVEL of EXTERNAL SIGNAL. A 1dB increase of EXT SIGNAL (over THRESHOLD) causes a 20dB increase in signal gain. PEAK detection, RANGE control active.

*THRESHOLD/OUTPUT GAIN COUPLING (Modes #2, 3, 5 and 6): In these modes, adjusting the THRESHOLD control to a lower setting causes an increased amount of limiting, or gain reduction, which ordinarily would cause a drop in output level.

The THRESHOLD-OUTPUT gain coupling feature computes the amount of make-up gain required to maintain a constant OUTPUT LEVEL during limiting (as indicated on the OUTPUT control in dB), regardless of the setting of the THRESHOLD control.

dyna-mite™

Multi-Function Dynamics Processor
A Product of VALLEY PEOPLE, INC., Nashville, Tenn.

	SWITCH SETTINGS			BASIC USE AREAS	FUNCTIONAL MODES	PARAMETERS
	S1 (DET)	S2 (MODE)	S3 (DET)			
1.	-	OUT	-	Bypass		Fixed gain. . . OUTPUT control active.
2.	INT	LIM	AVG	Apparent Level Limiting		Ratio = Inf:1, AVG detection of input signal, RANGE control inactive. See THRESHOLD/OUTPUT GAIN COUPLING*.
3.	INT	LIM	PEAK	Electrical Peak Limiting		Same as above, except PEAK detection of input signal.
4.	INT	LIM	GATE	Negative Limiting for "Organ Effects"		RATIO = 1:-20, PEAK detection of input signal, RANGE control active. As input signal exceeds THRESHOLD, a 1dB increase causes a 20dB decrease in output level.
5.	DS-FM	LIM	AVG	De-essing, FM Limiting		Same as #2, except Hi Freq EQ inserted in detector path.
6.	DS-FM	LIM	PEAK	De-essing, FM Limiting		Same as #3, except Hi Freq EQ inserted in detector path.
7.	DS-FM	LIM	GATE	Modified Negative Limiting		Same as #4, except Hi Freq EQ inserted in detector path.
8.	EXT	LIM	AVG	Inverse Envelope Follower, or "Soft Ducking"		Signal gain is determined by LEVEL of EXTERNAL SIGNAL. A 1dB increase of EXT SIGNAL (over THRESHOLD) causes a 1dB decrease in signal gain. AVG detection, RANGE active.
9.	EXT	LIM	PEAK	Inverse Envelope Follower		Same as above, except PEAK detection.
	EXT	LIM	GATE	Hard Ducking		A 1dB increase of EXTERNAL SIGNAL LEVEL (over THRESHOLD) causes a 20dB decrease in signal gain. PEAK detection, RANGE control active.
11.	INT	EXP	AVG	Expanding, Soft Noise Gating		Ratio = 1:2, AVG detection of input signal, RANGE control active.
12.	INT	EXP	PEAK	Expanding, Soft Noise Gating		Same as above, except PEAK detection.
13.	INT	EXP	GATE	Hard Noise Gating		RATIO = 1:20, PEAK detection of input signal, RANGE control active.
14.	DS-FM	EXP	AVG	Freq Selective Expansion		Same as #11, except Hi Freq EQ inserted in detector path.
15.	DS-FM	EXP	PEAK	Freq Selective Expansion		Same as #12, except Hi Freq EQ inserted in detector path.
16.	DS-FM	EXP	GATE	Freq Selective Noise Gating		Same as #13, except Hi Freq EQ inserted in detector path.
17.	EXT	EXP	AVG	Envelope Following Soft Keying		Signal gain is determined by LEVEL of EXTERNAL SIGNAL. A 1dB increase of EXT SIGNAL (over THRESHOLD) causes a 1dB increase in signal gain. AVG detection, RANGE control active.
18.	EXT	EXP	PEAK	Envelope Following Soft Keying		Same as above, except PEAK detection.
19.	EXT	EXP	GATE	Hard Keying		Signal gain is determined by LEVEL of EXTERNAL SIGNAL. A 1dB increase of EXT SIGNAL (over THRESHOLD) causes a 20dB increase in signal gain. PEAK detection, RANGE control active.



For handy reference, affix this label
to the top of your DYNA-MITE.

*THRESHOLD/OUTPUT GAIN COUPLING (Modes #2, 3, 5 and 6): In these modes, adjusting the THRESHOLD control to a lower setting causes an increased amount of limiting, or gain reduction, which ordinarily would cause a drop in output level. The THRESHOLD/OUTPUT gain coupling feature computes the amount of make-up gain required to maintain a constant OUTPUT LEVEL during limiting (as indicated on the OUTPUT control in dBv), regardless of the setting of the THRESHOLD control.

5. Maintenance

5.1 BRIEF CIRCUIT INFORMATION

The complete circuit operation is beyond the scope of this manual. A schematic diagram is provided to assist those users who possess sufficient electronic background to perform in-field test and repair work.

Power Supply. Power is supplied to the Dyna-Mite modules by an internal AC operated supply, which may be strapped for operation either at 115 or 230VAC at 50 to 60HZ.

The supply provides unregulated bipolar voltages to the circuit modules, each of which contains on-card regulation to provide the bipolar 15 volts used internally.

The power line fuse is mounted on the power supply board, and should be replaced with a similar unit, should a failure occur. Be sure that the unit is unplugged from the AC line, before disassembling the unit, as dangerous voltages exist on the power supply board. Disassembly should be restricted to qualified service personnel.

5.2 ADJUSTING THE TRIM POTS

Dyna-Mite uses a minimum number of circuit trims, and those which are present have been preset to their optimum position at the factory. In the event that any internal parts have been changed, it might be necessary for the technician making those changes to perform a re-adjustment procedure, to insure proper operation. For this purpose, the following adjustment procedure is provided:

1. Detector Balance Trim (R18). This trim assures that both halves of a bipolar input waveform are equally detected. To adjust this trim, the front panel switches should be set as follows: (1) INT; (2) PEAK; (3) LIMIT.

A 1KHz oscillator should be fed to the INPUT terminal, at a level of 0dBv (.775V RMS), and an AC coupled oscilloscope should be connected to Test Point #1 (Pin 7 of U5). R18 should then be adjusted such that alternate excursions of the displayed waveform are of equal magnitude.

2. Threshold Trim (R24). This trim calibrates the THRESHOLD point, and has a strong effect on the accuracy of the THRESHOLD/GAIN coupling feature inherent in the basic limit modes. It should be adjusted as follows:

Use the same setup as in #1 above. Use of the oscilloscope is not necessary for this adjustment. An AC meter capable of indicating 0dBv (.775V RMS) should be connected to the OUTPUT connector. Set the THRESHOLD control to the -10dBv scale marking.

With the 1KHz oscillator connected to the INPUT connector, adjust the OUTPUT control to the 0dB scale marking. (Make sure the knob is centered on the potentiometer shaft.)

Adjust R24 such that the observed meter reading at the device output is 0dBv (.775V RMS). Once this adjustment has been

properly made, and assuming the input oscillator is accurately set to deliver 0dBv to the input, small adjustments should now be made to the front panel THRESHOLD control, while observing the action of the gain reduction LEDs. The 10dB gain reduction LED should come on when the THRESHOLD control is in the vicinity of its -10dBv scale marking. If necessary, reposition the THRESHOLD knob on the potentiometer shaft slightly, to achieve an accurate correlation between the coincidence of the -10dBv scale mark and illumination of the 10dB gain reduction LED. Due to the small knob and pot sizes involved, small errors in the accuracy of the knob calibrations are to be expected.

If errors seem to be excessively large after the calibration procedure, the following test will help determine the severity of these errors:

Using the same setup, reduce the THRESHOLD control to its full CCW position (-40dBv). Configure the test oscillator such that its output may be varied over the range of -35dBv to -45dBv (still 1KHz). While observing the gain reduction LEDs, adjust the oscillator output level such that the 1dB gain reduction LED just comes on. Now measure the output level of the oscillator. With proper calibration, the oscillator should now be producing -39dBv, +/- 3 dB.

3. VCA Rejection Trim (R101). (Accessible through the back panel.) This trim balances the VCA such that maximum rejection of the control signal is realized. Should this adjustment be substantially off, cracking or clicking sounds may be heard in the output signal during operation. The easiest and best field adjustment of this trim is performed by ear—without test equipment, using the following procedure:

a. Set the front panel switches as follows: (1) EXT; (2) EXP; (3) PEAK.

b. Set RANGE to maximum (CCW), OUTPUT to maximum (CW), and RELEASE to minimum (CCW).

c. Monitor the output of the device with a monitor amplifier/speaker.

d. Apply a rapidly changing music source to the EXTERNAL INPUT (drums are ideal). Make *no* connection to the INPUT connector.

e. Adjust the THRESHOLD control such that the maximum movement of the gain reduction LEDs is accomplished.

f. While listening to the monitor speaker, slowly adjust R101 for minimum sound in the monitor... thus maximizing rejection of the control signal. Do not be alarmed if this signal sounds distorted and noisy; it will in normal operation. If you wish to verify the amount of control rejection achieved, you may connect an oscilloscope to the output terminal, and observe the output signal. You should be able to adjust for no more than 20mv of output signal (control leakage) under these conditions.

5.3 WARRANTY

VALLEY PEOPLE, INC. warrants its products and their related enclosures and power supplies to be free from defects in workmanship and material under normal use and service. Said warranty is to extend for a period of twelve months after date of purchase. In the case that a VALLEY PEOPLE, INC. product or any of its related enclosures or power supplies is believed to be defective, same may be returned with transportation prepaid to VALLEY PEOPLE, INC., within twelve months after date of purchase, accompanied by proof of purchase. If the product is found by VALLEY PEOPLE, INC.'s inspection to be defective in workmanship or material, it will be repaired or replaced (at VALLEY PEOPLE, INC.'s election) free of charge and returned, transportation prepaid, to any point in the United States. If inspection by VALLEY PEOPLE, INC. of such products does not disclose any defect in workmanship or material, VALLEY PEOPLE, INC.'s regular charges will apply.

This warranty is expressed in lieu of any and all other warranties, whether expressed or implied, and the sole liability of VALLEY PEOPLE, INC. under this warranty is to either repair or replace (at VALLEY PEOPLE, INC.'s election) the product or its related enclosure or power supply. Any incidental damages are expressly excluded.

The foregoing warranty is VALLEY PEOPLE, INC.'s sole warranty, and all other warranties, expressed, implied, or statutory, are negated and excluded.

6. Illustrations

5.1 GRAPHS OF CONTROL FUNCTION

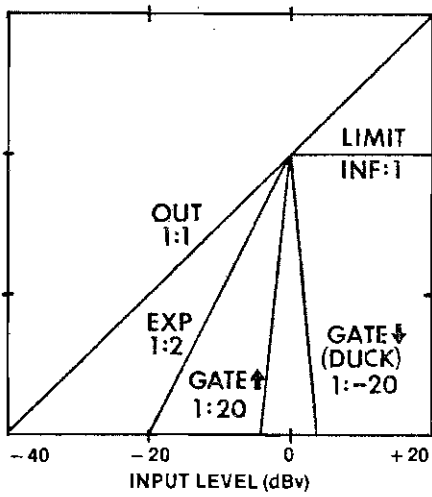

FIGURE 1
BASIC TRANSFER CHARACTERISTICS (INTERNAL DETECT MODE)
 THRESHOLD: 0dBv
 RANGE: 60dB
 OUTPUT: 0dB

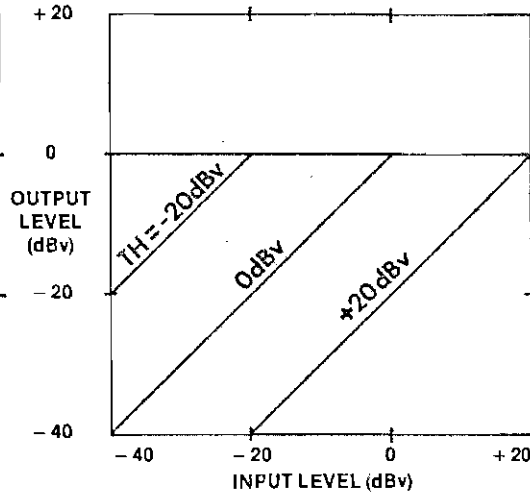

FIGURE 2
EFFECT OF THRESHOLD IN LIMIT MODE
 DETECT MODE: INTERNAL
 OUTPUT: 0dB
 RANGE: NOT APPLICABLE

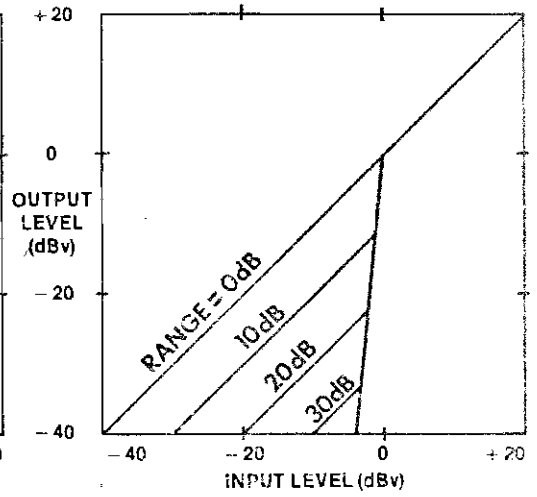

FIGURE 3
EFFECT OF EXP/GATE/DUCK RANGE CONTROL
 DETECT MODE: INTERNAL
 OUTPUT: 0dB
 THRESHOLD: 0dBv
 (SHOWN IN GATE UP MODE)

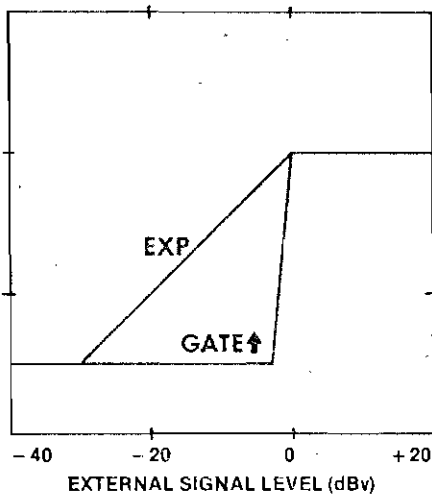

FIGURE 4
SIGNAL GAIN IN RESPONSE TO EXTERNAL CONTROL SIGNAL (EXT DETECT MODE)
 THRESHOLD: 0dBv
 RANGE: 30dB
 OUTPUT: 0dB

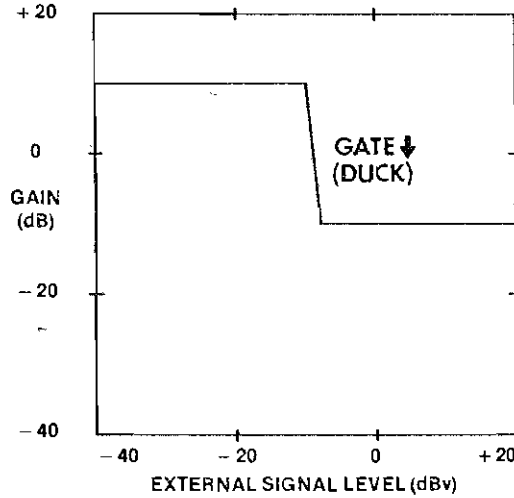

FIGURE 5
SIGNAL GAIN IN RESPONSE TO EXTERNAL CONTROL SIGNAL (EXT DETECT MODE)
 THRESHOLD: -10dBv
 RANGE: 20dB
 OUTPUT: +10dB

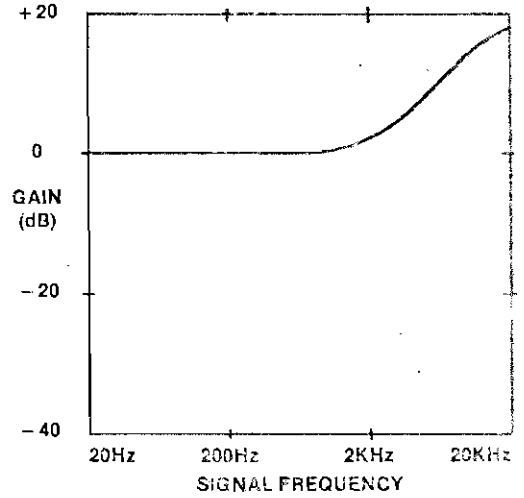
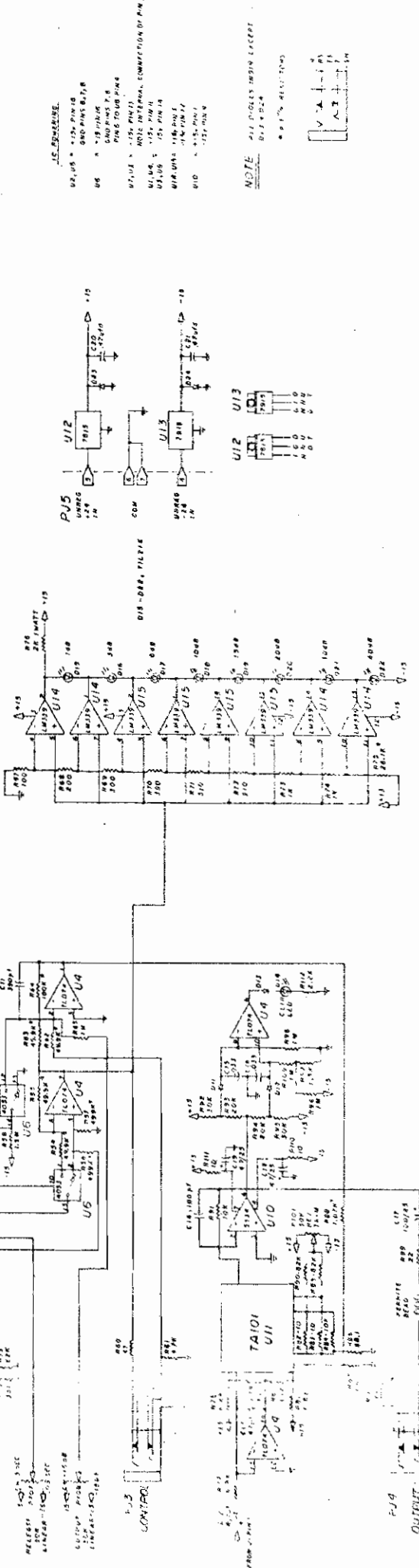
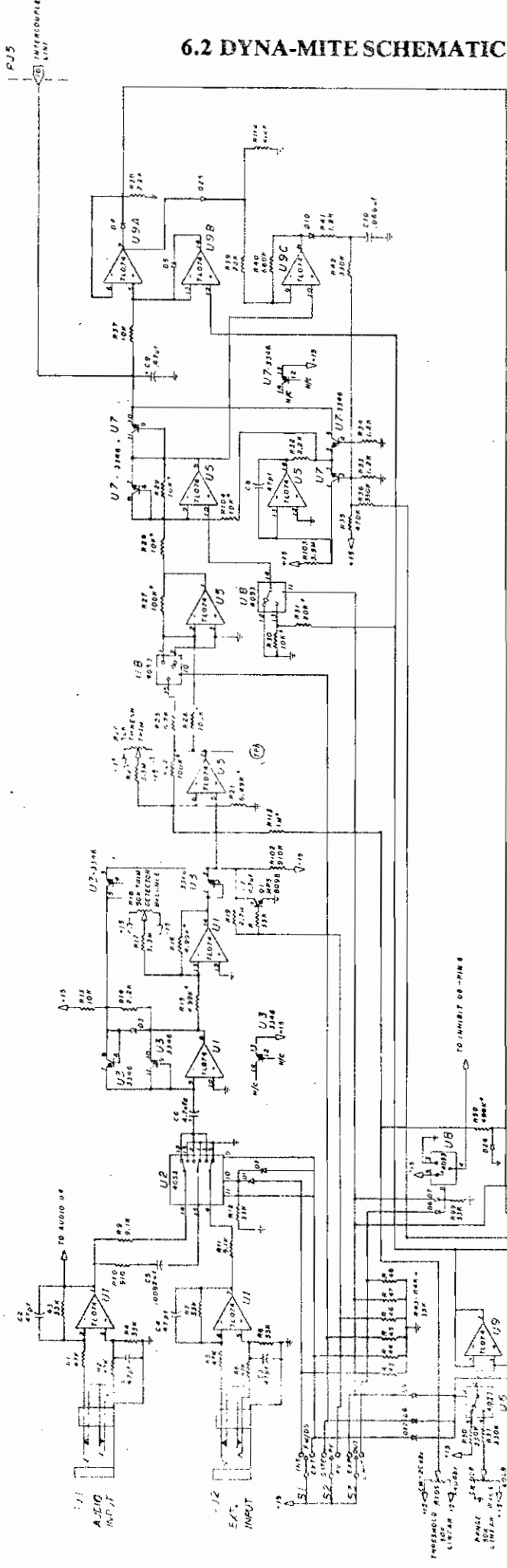

FIGURE 6
SIDE BAND EQUALIZATION APPLIED TO INPUT SIGNAL IN FM-DS MODE (ACTUAL OUTPUT SIGNAL IS NOT EQUALIZED)

6.2 DYNA-MITE SCHEMATIC



- IC POWERISE**
- U2, U5 = 7410 - PIN 14
 - U6 = 7410 - PIN 14
 - U7, U8 = 7410 - PIN 14
 - U9, U10 = 7410 - PIN 14
 - U11 = TA101
 - U12, U13 = 7410 - PIN 14

NOTE



6.3 DYNA-MITE PARTS OVERLAY

CONTROL REJECTION

DETECTOR BALANCE

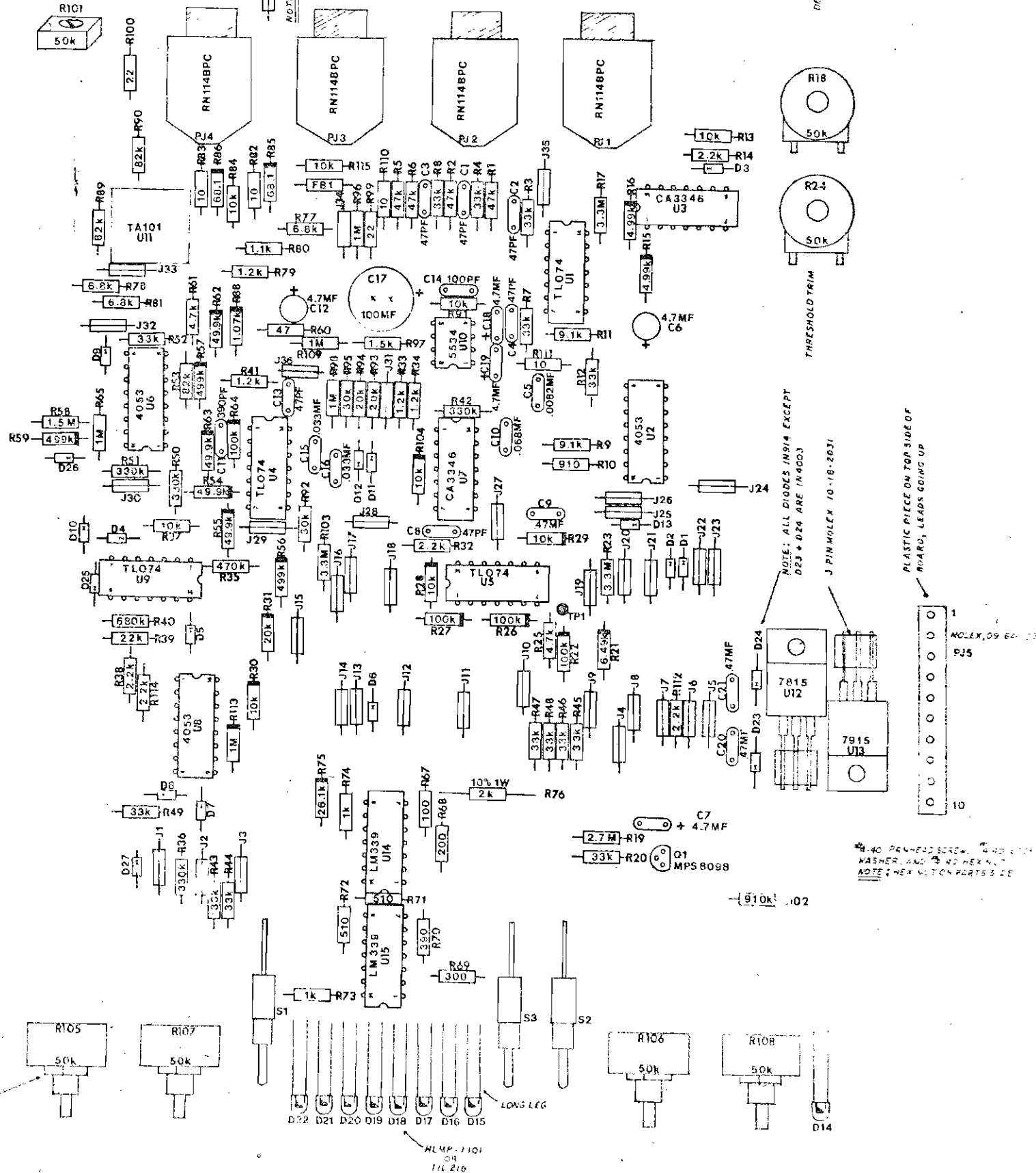

NOTE: TANALUMS: C7, C18 & C19
ELECTROLYTICS: C5, C12 & C17

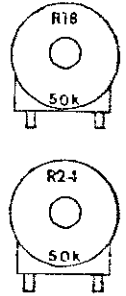

THRESHOLD TRIM

PLASTIC PIECE ON TOP SIDE OF BOARD, LEADS GOING UP

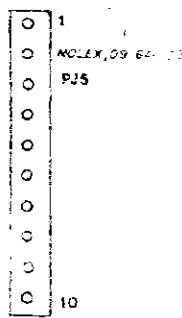

NOTE: ALL DIODES IN 914 EXCEPT D23 & D24 ARE IN-4003

J PIN MOLEX 10-18-2031

* 40 PIN-HEAD SCREW, 1/8" DIA. 1/16" WASHER, AND #40 HEX NUT
NOTE: HEX NUT ON PARTS SEE

NOTE: 57K

6.4 POWER SUPPLY

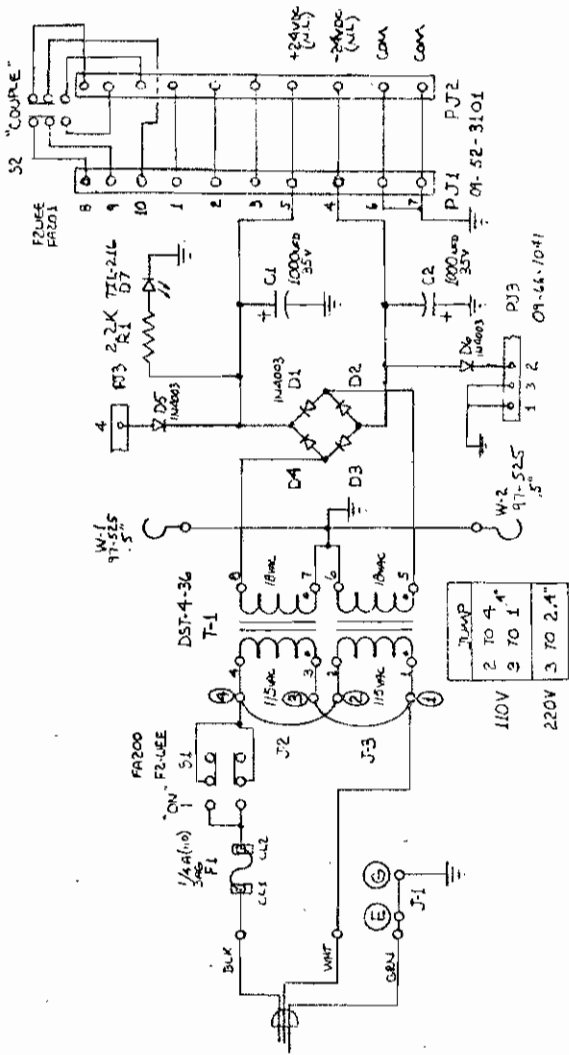

NOTE:
 J2&J3 SHOWN FOR 110V OPERATION
 J4 ONLY FOR 220V OPERATION
 WITH#2 ON POIL SIDE
 F1-1/4 AMP NORMAL BLOW-110V
 F1-1/8 AMP NORMAL BLOW-220V
 ALL DIODES IN4003

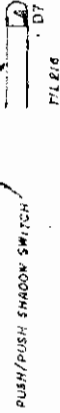
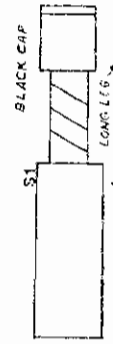
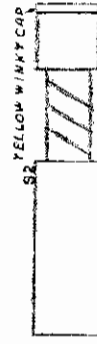
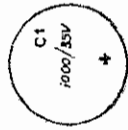
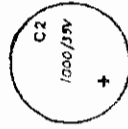
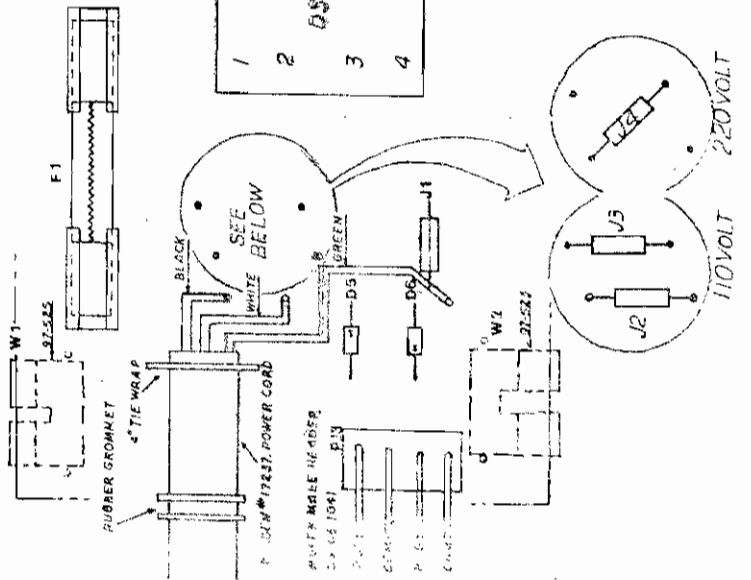

PROJECT		Valley People Inc.	
TITLE		OVERLAY DYNAMITE POWER SUPPLY	
DATE	DESIGNER	DATE	DESIGNER
10/27/61	J.C.C.	10/27/61	J.C.C.
DRAWN BY		B-133	