

OWNER'S MANUAL

PCM 70

DIGITAL EFFECTS PROCESSOR

With Rev. 2.00 Software

lexicon

Unpacking and Inspection

After unpacking the PCM 70, save all packing materials in case you ever need to ship the unit. Thoroughly inspect the PCM 70 and its packing materials for signs of damage in shipment. Report any damage to the carrier at once.

Precautions

The Lexicon PCM 70 is a rugged device with extensive electronic protection. However, reasonable precautions applicable to any piece of audio equipment should be observed.

- Always use the correct AC line voltage. Refer to Chapter 1 of this manual for power requirements.
- Do not install the PCM 70 in an unventilated rack, or directly above heat-producing equipment. Maximum ambient operating temperature is 35°C (95°F).
- Never attach audio power amplifier outputs or other power sources directly to any of the PCM 70's connectors.
- Before turning the PCM 70 on or off, mute your monitor speakers to avoid possible damage from transients.
- To prevent fire or shock hazard, do not expose the PCM 70 to rain or moisture.

Notice

Lexicon, Inc. reserves the right to make improvements in this manual and the product it describes at any time and without notice or obligation.

Copyright (c) 1985

Lexicon, Inc.
100 Beaver Street
Waltham, MA 02154 USA
(617) 891-6790
Telex 923 468

All Rights Reserved

This publication is protected by copyright and all rights are reserved. No part of it may be reproduced or transmitted by any means or in any form, without prior consent in writing from Lexicon.

Table of Contents

	TWO-MINUTE TUTORIAL	iv
	NEW FEATURES IN PCM 70 SOFTWARE VERSION 2.00	vi
	INTRODUCTION	vii
1	INSTALLING THE PCM 70	1-1
	Power Requirements.....	1-1
	Mounting.....	1-1
	About the Rear Panel.....	1-2
	Making the Right Connections	1-3
2	GETTING STARTED WITH THE PCM 70	2-1
	About the Front Panel	2-1
	The PCM 70 Operating System.....	2-2
	Using the Program Mode	2-3
	Using the Parameter Mode.....	2-4
	Using the Master Parameters.....	2-6
	Using the Register Mode.....	2-6
	Naming Registers.....	2-7
	Register Protection.....	2-7
	Setting Audio Levels.....	2-8
	A Good Start.....	2-8
3	WHAT THE PARAMETERS DO	3-1
	Effects Parameters.....	3-1
	Reverb Parameters	3-4
	Control Parameters.....	3-7
4	USING THE PRESET PROGRAMS	4-1
	Parameter Tables.....	4-2
5	MIDI AND THE PCM 70	5-1
	MIDI Connections.....	5-2
	Applications.....	5-7
	Transferring Registers Between PCM 70s.....	5-11
	Remote Control and Patch Storage with a Computer	5-11
6	TECHNICAL DESCRIPTIONS OF THE PROGRAMS	6-1
7	SOLVING PROBLEMS	7-1
8	SPECIFICATIONS AND MIDI IMPLEMENTATION DATA	8-1
	Specifications.....	8-1
	MIDI Implementation Data.....	8-3

Minute 00:00 and Counting

Lexicon PCM 70

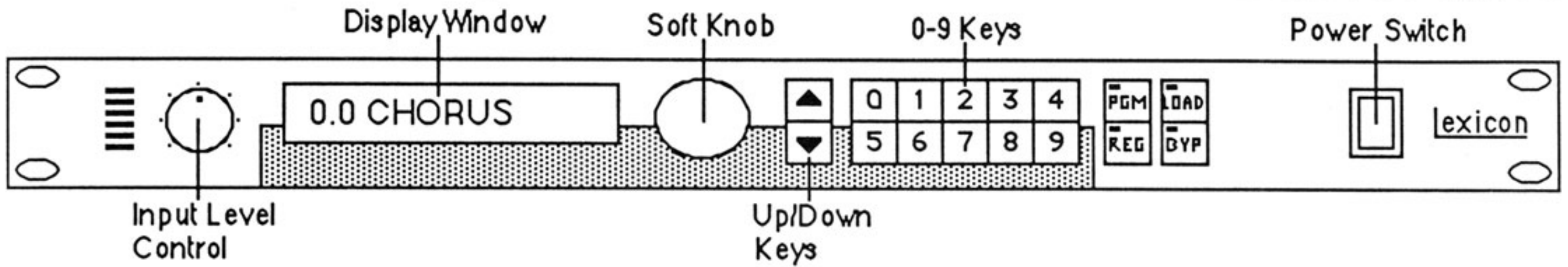

Audio and Power

Make appropriate audio connections on rear panel. → Turn PCM 70 power switch on. → Set audio input level to PCM 70. All LEDs (except the red "0 dB" LED) should flash on peaks.

Program Matrix

Is LED in PGM key lit? If not, press the key. → Use the Up/Down keys to scan up and down rows:
 ↑ 0 _____
 1 _____
 2 _____
 3 _____
 4 _____
 ↓ etc.....

Use the 0-9 keys to scan across columns:
 ← Columns →
 0 1 2 3 4 5 etc.
 | | | | | | |
 Together, the rows and columns make up a matrix of all the programs in the PCM 70:

	.0	.1	.2	.3	.4	.5	.6	.7	.8	.9
0.	Chorus	Chorus Echoes	Echo Flange	Stereo Flange	Double Slap	Spin Echoes	Swarble	Psycho Echoes	Echoes BPM	Chorus & Echo B
1.	Single Delay	Double Delay	Pan Delay	Circular Delays	4 Voice Delay	Quatro Delays	Filtered Delays	Shuffle BPM	Bouncing BPM	
2.	Major Chord	Minor Chord	7th # 11	Dom 13th	Rym in C BPM	Rym C min BPM				
3.	Concert Hall	Long Hall	Gym							
4.	Rich Chamber	Small Room	Tiled Room	Gated Chamber	Infinite Reverb					
5.	Rich Plate	Small Plate	Gated Plate							
6.	Echo BPM	Cascade BPM	Filter Pan B	MIDI Chord B	MIDI Slap BPM	MIDI CT Hall	MIDI Inf Reverb			
7.	Control Program	Cor Reg Table								

PCM 70 Program Matrix



Loading Programs

Use the Up/Down keys and 0-9 keys to select the program you want to load. Then press the LOAD key.

Editing Parameters

Each program in the PCM 70 has a set of parameters that you can edit to change a program's sound. The parameters are organized into a matrix of rows and columns—just like the programs. For example:

	.0	.1	.2	.3	.4	.5	.6	.7	.8	.9
0.	Mix	FX Adj	Soft Knob	Chorus	Chorus Mode	HC	Diffusion	Parameter Matrix: Chorus and Echo Programs		
1.	Level Master	Y1 Level	Y2 Level	Y3 Level	Y4 Level	Y5 Level	Y6 Level			
2.	Delay Master	Y1 Delay	Y2 Delay	Y3 Delay	Y4 Delay	Y5 Delay	Y6 Delay			
3.	Fdback Master	Y1 Fdback	Y2 Fdback	Y3 Fdback	Y4 Fdback	Y5 Fdback	Y6 Fdback			
4.	Pan Master	Y1 Pan	Y2 Pan	Y3 Pan	Y4 Pan	Y5 Pan	Y6 Pan			
5.	MIDI Patches	MIDI Patches	MIDI Patches	MIDI Patches	MIDI Patches	MIDI Patches	MIDI Patches	MIDI Patches	MIDI Patches	

To access a program's parameters, press the **PGM** key to turn off its LED. You are now at location 0.0 in the parameter matrix. Use the  and  keys to move around the matrix. and



0	1	2	3	4
5	6	7	8	9

 keys to move around the matrix.

Use the Soft Knob to change the value of a selected parameter. 

Storing Registers

Is LED in **REG** key lit? If not, press the key.

Use the  and  and

0	1	2	3	4
5	6	7	8	9



 keys to locate an unused register. There are 50 registers in the PCM 70.

Press and hold the **REG** key. While holding down the **REG** key, press the **LOAD** key. You should see:



Loading Registers

Is LED in **REG** key lit? If not, press the key.

Use the  and  and

0	1	2	3	4
5	6	7	8	9

 keys to select the register you want to load. Then press the **LOAD** key.

Stop Clock
01:58

This completes the basic introduction to the PCM 70. For a detailed explanation of many features not covered here, read the *PCM 70 Owner's Manual*.

New Features in PCM 70 Software Version 2.00

MIDI System Exclusive

The PCM 70 now receives and processes MIDI System Exclusive messages for parameter and patch changes. Registers and the current running program can also be sent and received. Several software houses are producing software for the PCM 70. Check the pages of any of the popular keyboard and music magazines for more information.

MIDI Program Changes

If the PCM 70 receives a MIDI program change command for the currently-running program or register, it is ignored (unless the currently-running program or register has been edited). In previous software versions, a MIDI program change message caused the PCM 70 to load a program or register even if it was already running.

Sending a Bank of Registers

The procedure for sending a bank of registers from one PCM 70 to another has been simplified. See page 5-11 for new instructions.

Chorusing Parameter

MIDI controllers and the Softknob can now be patched to this parameter.

Crossover Parameter

The crossover parameter now has a lower limit of 170 Hz.

New Display Feature

When loading a program or register, the PCM 70 now displays "LOADING PROGRAM" or "LOADING REGISTER" *while* loading instead of "PROGRAM LOADED" or "REGISTER LOADED" *after* loading.

Introduction

Welcome to the world of Lexicon. The PCM 70 Digital Effects Processor gives you access to the same astonishing digital effects used by the world's top artists and studios--all in a compact single-space rack mount unit.

- The PCM 70 offers more than 40 digital effects and reverb programs, including chorus and echo, resonant chords, multiband delays, rich chamber, rich plate, and concert hall. Add to these the 50 programs you can create and store in user registers, and you have instant access to more than 90 programs.
- If creative control is what you are after, more than 70 different parameter types can be edited to produce just the sound you need. Everything from delay times to feedback, filters, panning, and early reflections.
- Great sounds are only half the story. The PCM 70 introduces revolutionary MIDI capabilities that will change forever the way the world uses effects. Lexicon's Dynamic MIDI™ gives you real-time remote control over up to ten different parameters at the same time from a MIDI keyboard or sequencer. You can patch any effects or reverb parameter to any variable MIDI controller on your synthesizer--modulation wheel, pitch wheel, data entry slider, sustain switch, and others. You can also patch parameters to vary with MIDI events like key velocity, pressure, or aftertouch.
- If you have a sequencer, control changes sent to the PCM 70 from your keyboard or controller can be recorded and repeated perfectly--every time.
- A corresponding register feature lets you choose effects or reverb programs remotely, from sequencers, synthesizers, and other MIDI devices.
- To top it all off, an innovative and uncomplicated user interface ensures that you can access all of this power quickly and easily.

These features give the PCM 70 capabilities far beyond any other effects processor available. To make sure you don't miss out on anything, we'd like you to read this book. If you aren't ready to read all of it right now, at least read the first couple of chapters. They contain essential information you need to get started.

Installing the PCM 70

Power Requirements

The PCM 70 is equipped with a three-pin IEC connector and detachable power cord, providing chassis grounding to the ac mains line. It can be operated at either 100/120 Vac or 220/240 Vac, depending on the setting of an internal voltage changeover switch, a jumper, and the rating of the internal mains fuse.

The nominal operating voltage set at the Lexicon factory is marked on a label affixed to the rear panel. Check this label before applying power to the unit!

Maximum power consumption is 25 W. The following table lists the nominal operating voltages, jumper positions, and appropriate fuse ratings.

AC Line Voltage	Jumper Position	F1 Fuse Rating
100V	E24 - E23	1/4A 3AG Slo-Blo
120V	E24 - E22	1/4A 3AG Slo-Blo
220V	E24 - E23	1/8A 3AG Slo-Blo
240V	E24 - E22	1/8A 3AG Slo-Blo

Table 1.1. Jumper Positions and Fuse Types.

Voltage Changeover

Voltage Changeover must be performed by a qualified service technician only. To change the operating voltage of your PCM 70, have a qualified technician carry out the following procedure:

1. Set the voltage option switch (SW3) to the proper line voltage.
2. Set the power supply jumper (below the voltage option switch) to the proper line voltage, as shown in Table 1.1.
3. Replace fuse F1 with the correct fuse, as shown in Table 1.1.

Mounting

The PCM 70 measures 19" wide x 1.75" high x 13.5" deep (483 x 45 x 344 mm) and can be mounted in a standard 19-in. (483 mm) relay rack. Do not install the PCM 70 above heat-producing equipment like power amplifiers; its maximum ambient operating temperature is 35°C (95°F).

If the PCM 70 is mounted in a rack or road case, support the rear of the chassis during transport to prevent possible damage from mechanical shock.

About the Rear Panel

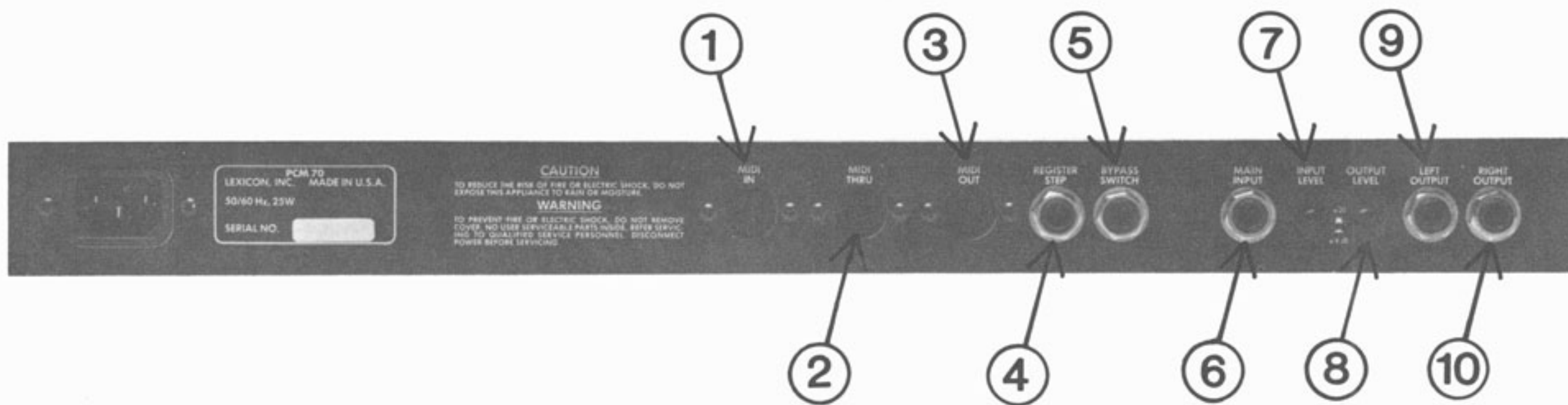

1 MIDI In

The MIDI In jack receives MIDI information from another MIDI-equipped device, such as a synthesizer or a sequence recorder.

2 MIDI Thru

The MIDI Thru jack retransmits MIDI information received at the MIDI In jack, without any change.

3 MIDI Out

The MIDI Out jack sends MIDI program change information from the PCM 70 to another MIDI-equipped device.

4 Register Step

This jack steps through the programs or registers in the current row. It accepts a 1/4-in. phone plug (tip/sleeve) wired to a momentary contact footswitch (we suggest Lexicon footswitch 750-02834 or A-FS-41).

5 Bypass

This jack allows remote control of the bypass function. It accepts a 1/4-in. tip/sleeve phone plug for connection to an optional locking footswitch (we recommend Lexicon footswitch A-FS-41.)

The PCM 70 can be placed in bypass mode from either the rear panel bypass switch jack or the front panel switch. The Bypass key indicator lights when the unit is in bypass mode. In the bypass mode, the signal continues to pass through some of the PCM 70's circuitry. The input signal is electronically routed to both left and right outputs, and the input level control remains effective.

6 Main Input

This jack is the audio input to the PCM 70. It accepts a 1/4-in. tip/ring/sleeve or tip/sleeve plug. Levels and impedance are determined by the Input Level pushbutton. In the +4 dB sensitivity mode the input matches balanced or unbalanced studio-level signals; in the -20 dB sensitivity mode the input matches unbalanced high impedance signals from instruments, microphones, and other low-level equipment.

7 Input Level

This pushbutton selects levels and impedance for the Main Input:

- +4 dB: -8 to +18 dBV balanced or unbalanced, 40 kilohms parallel with 150 pF.
- 20 dB: -23 to +3 dBV unbalanced, >500 kilohms parallel with 150 pF.

8 Output Level

This pushbutton selects levels for the Left and Right Outputs:

+4 dB: + 10 dBV maximum output into 600 ohms; +16 dBV maximum output into 10 kilohms or greater.

-20 dB: -8 dBV maximum output into 10 kilohms or greater.

9 Left and Right Outputs

The Left and Right audio output jacks accept 1/4" tip-ring-sleeve phone plugs. Output Level is determined by the program currently in use, and the Output Level pushbutton discussed above. Output impedance is 600 ohms, regardless of level setting.

When connecting the PCM 70 to a mono system, use either of the two output jacks. The left and right signals are summed internally when only one jack is used.

Making the Right Connections

This section outlines some wiring possibilities for the PCM 70. Every recording and sound reinforcement system is unique, and we recommend that you experiment to arrive at the best configuration for your own system. Actual connections should be checked carefully for proper impedance, polarity, and levels. This section discusses audio connections only. For MIDI connections, see Chapter 5, *MIDI and the PCM 70*.

Connection to a Mixing Console

The PCM 70 is a mono input, stereo output device. If your system includes a mixing console or an instrument amplifier with one or more auxiliary or effects loops, connect it as shown in Figure 1.1 below. In some applications it may be preferable to connect the PCM 70 outputs to two of the console's input channels, rather than using effects returns. In either case, the PCM 70 outputs should be panned full left and right.

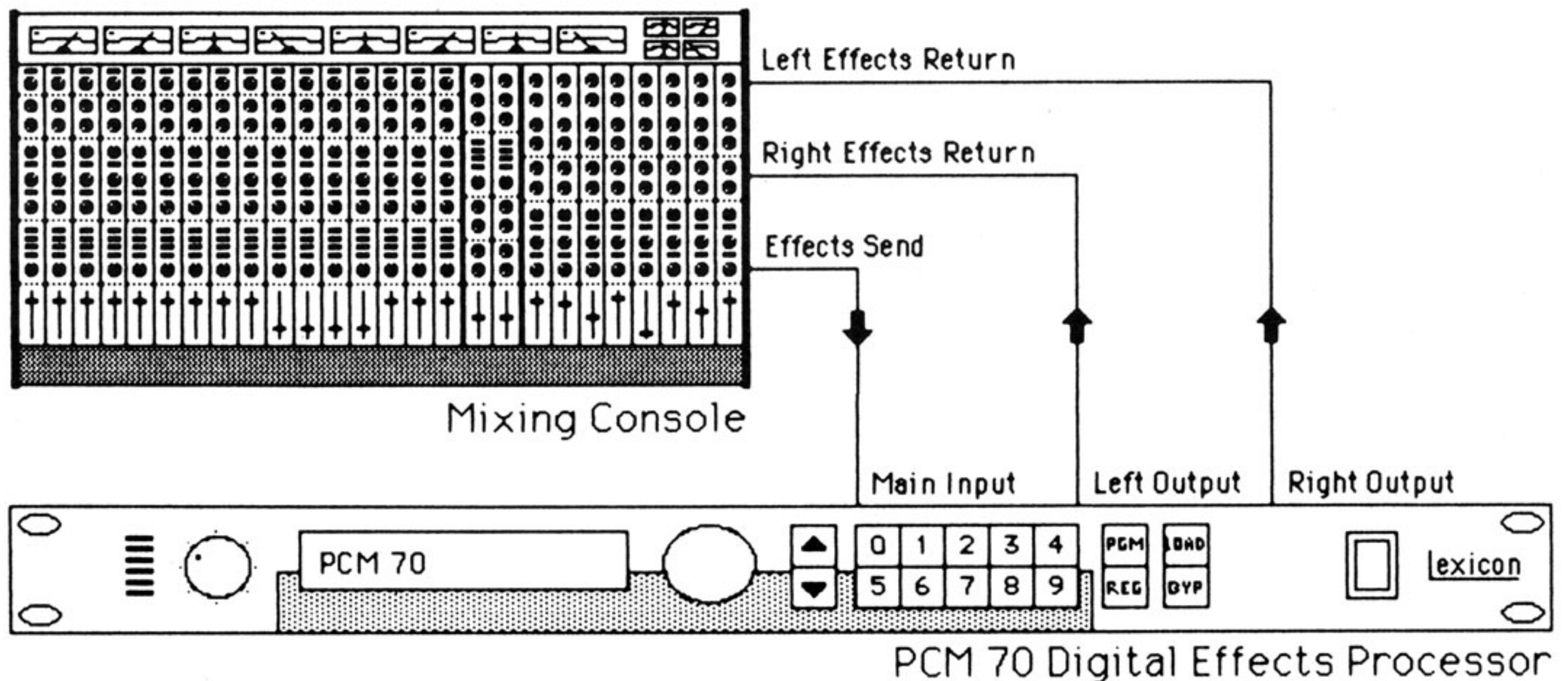

Figure 1.1. Connection to mixing console.

Connection to Instrument and Amplifiers

If you will be connecting the output of a microphone or musical instrument directly to the PCM 70, connect the system as shown in Figure 1.2 below. If the instrument has stereo outputs, use the instrument's output recommended for mono applications.

Using the PCM 70 in Mono

The PCM 70 produces excellent stereo effects from a mono signal source. Consequently we recommend that you use the PCM 70 in stereo whenever possible. However, if mono output is required, you can use either of the two rear panel output jacks.

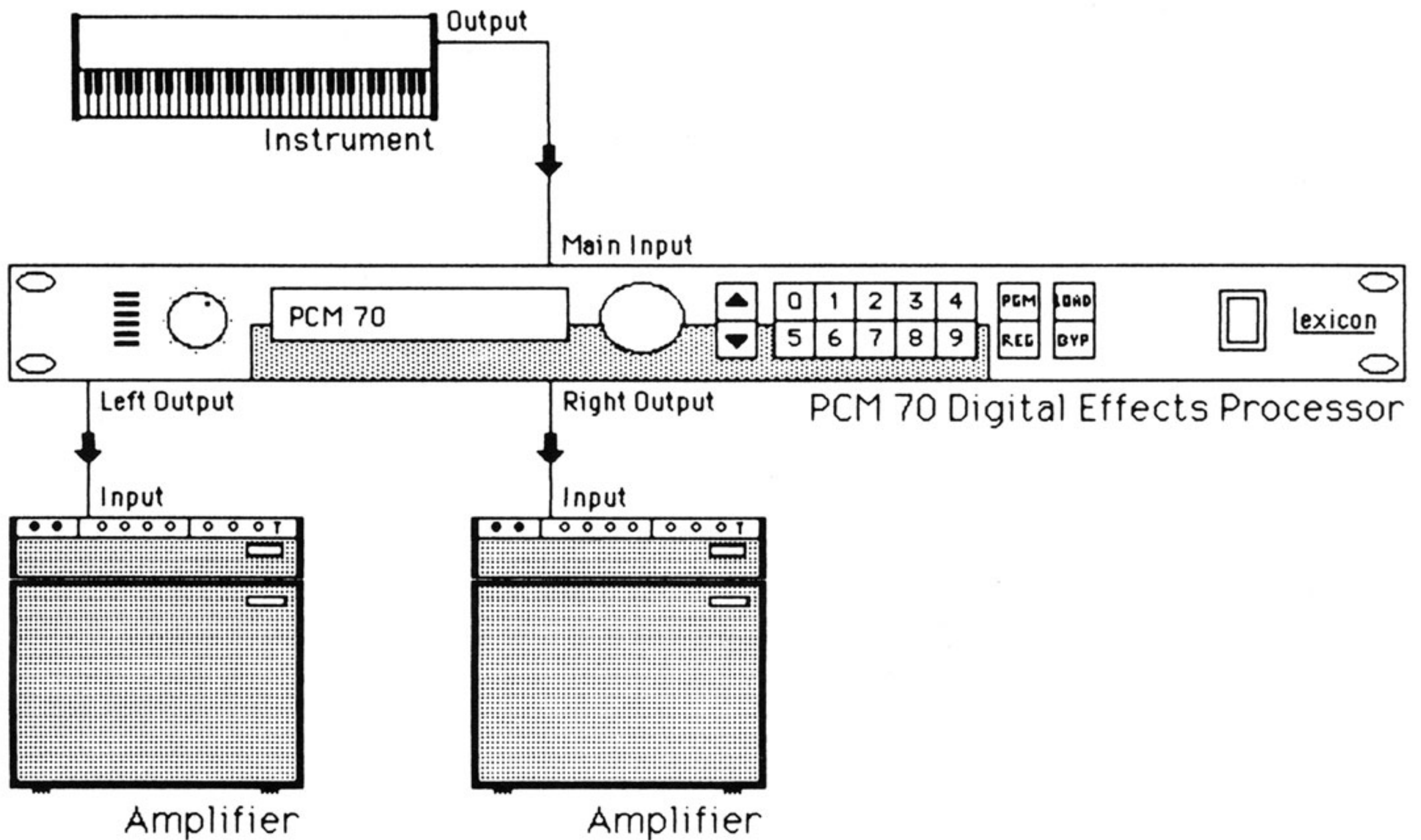
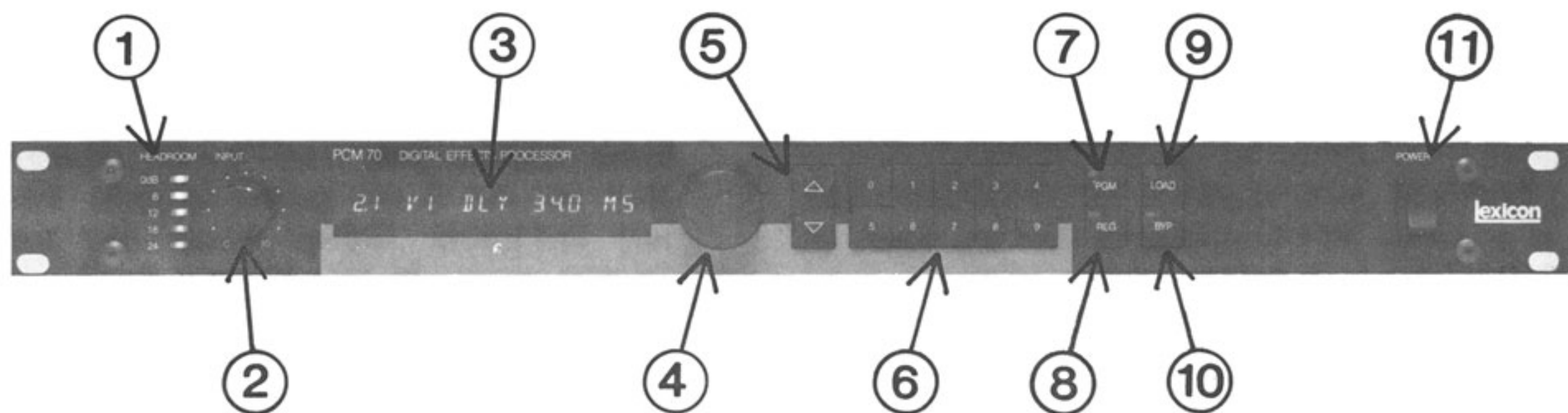

Figure 1.2. Connection to instrument and amplifiers.

Getting Started With the PCM 70

About the Front Panel



1 Headroom Indicator

This five-segment LED display shows signal level and headroom available for the input signal. For optimum performance, adjust the input level so that all the LEDs *except* the red 0 dB indicator flash on peaks. When the red LED flashes there is no more headroom available before clipping or overload occurs. The input signal level is too high, and should be reduced.

2 Input Level Control

This rotary knob controls the level of the input signal. If the red LED in the headroom indicator flashes, lower the input level with this control.

3 Display Window

The Display Window indicates the location number and name of a selected program or register, or it displays a selected parameter.

4 Soft Knob

The Soft Knob is used together with the Display Window to edit the PCM 70's variable parameters.

5 Up and Down Keys

The Up and Down keys are used to select a row of programs, registers, or parameters.

6 0-9 Keys

The 0-9 keys are used to move from column to column within a row. Used in combination with the Up and Down keys, they allow you to move rapidly to any preset program, register, or parameter.

7 PGM Key

The PGM (Program) key toggles the PCM 70 in and out of the program mode. When the LED in the upper left-hand corner of the key is lit, the unit is in the program mode, and the Up, Down, and 0-9 keys may be used to select a preset program. The number and name of the selected program will appear in the display window. **Note:** The selected program isn't actually loaded until you press the Load key.

If the PGM key is pressed and held, the family of preset programs that the current program or register is derived from appears in the display window.

8 REG Key

The REG (Register) key toggles the PCM 70 in and out of the register mode. When the LED in the upper left-hand corner of the key is lit, the unit is in the register mode, and the Up, Down, and 0-9 keys may be used to select a register. The number and name of the selected register will appear in the display window. Note: A register isn't actually loaded until you press the Load key.

A register may be identical to a preset program, or it may contain a modified (edited) version of a program. If the REG key is pressed and held, the display window indicates the program or register number that was most recently loaded, and whether or not it is in an original or modified form.

9 LOAD Key

Press the LOAD key briefly to load a selected program or register into the PCM 70. When the LOAD key LED is lit (and the PCM 70 is in the parameter mode) its function varies, depending upon which parameter is active.

10 BYP Key

When the BYP (Bypass) key is pressed briefly, a small LED in the upper left-hand corner of the key lights, and all processing functions are bypassed, i.e., the main input is directly connected to both outputs. Press the BYP key again and the PCM 70 will return to normal operation. The bypass function may also be controlled with an optional remote footswitch.

11 Power Switch

The Power switch turns the PCM 70 on and off; the unit powers up in the same condition it was in when it was last turned off. The PCM 70 has a lithium backup battery which maintains the data memory even when power is off or the unit is disconnected.

The PCM 70 Operating System

The PCM 70's front panel is deceptively empty. A small number of knobs and switches together with the display window perform hundreds of functions, depending upon which operating mode is currently active. There are three operating modes:

- Program Mode
- Register Mode
- Parameter Mode

The *program mode* is used to select and load preset programs--sets of instructions that tell the PCM 70 how to process the input signal. One program may produce chorusing, another echoes, another reverberation, and so on. The preset programs are permanently stored on ROM chips inside the PCM 70, and they cannot be accidentally erased or altered.

The *parameter mode* is used to adjust the various controls (parameters) within a program, altering or editing the sound of a program.

Once a program has been edited, the new parameter settings can be stored in a register. The *register mode* is used to select, load, and store these registers.

A Synthesizer-Like Interface

If you are familiar with synthesizers, you will discover that the PCM 70's programs, registers and parameters are organized and accessed like the programs and parameters on many popular synthesizers.

Using the Program Mode

The PCM 70 is shipped with approximately 40 preset programs (the exact number may vary, depending upon the version of the software supplied with your unit.) This section describes how to select and load programs. Detailed information about the programs themselves is found in Chapter 4, *Using the Preset Programs*.

To allow quick and efficient program selection, the PCM 70 has a directory containing the name of each program. The directory is organized in a matrix of rows and columns, as shown in Figure 2.1. (If you're familiar with computer spreadsheets, you'll feel right at home with this system.)

If the PCM 70 had a very large display screen, you could view the entire program directory on the screen at the same time. However, to keep things compact we have supplied a movable display window that lets you view a single item at a time. When an item appears in the display window, we say that it is *selected*.

0 0 CHORUS	0 1 CHORUS ECHOES	0 2 ECHO FLANGE
1 0 SINGLE DELAY	1 1 DOUBLE DELAY	1 2 PAN DELAY
2 0 MAJOR CHORD	2 1 MINOR CHORD	2 2 7TH SHARP 11
3 0 CONCERT HALL	3 1 GYMNASIUM	3 2 ROOM
4 0 RICH CHAMBER	4 1 SMALL	4 2 E
5 0 RICH PLATE	5 1 SMALL	5 2 E

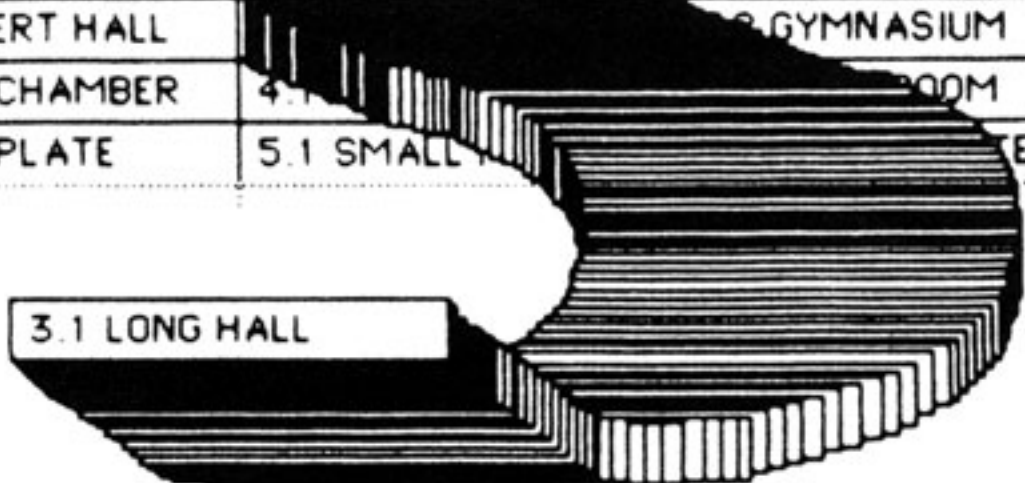

The Up, Down, and 0-9 keys are used to move the display window over the directory. If you press the Down key once, the display window moves down to the next row. Press the Up key once, and it returns to the previous row.

Each of the 0-9 keys corresponds to a column within the selected row. Pressing one of these keys moves you directly to that column.

Some columns within a row may not be in use. If you try to move to one of them, a "NOT AVAILABLE" message appears in the display window.

A Unique Name for Every Program

How do you know where the display window is located within the directory? Each program has a unique name and a location number which identifies the current row and column of the display window. If you see:

4.0 RICH CHAMBER

you know that the Rich Chamber program is selected. The two-digit number to the left of the program name is the location number. The digit to the left of the decimal point is the row number, and the digit to the right of the decimal point is the column number.

With only a couple of exceptions, programs in the same row are related to each other--they use the same basic program to create their sound. For example, row 0 contains a variety of Chorus and Echo programs, and row 4 contains Rich Chamber reverberation programs. **To display the type of programs that are stored in the current row, press and hold either of the Up or Down keys.**

How to Select a Program

1. Enter the program mode by pressing the PGM key briefly. The LED in the PGM key lights when the program mode is active. If the LED doesn't light, the PCM 70 is still in the parameter mode--press the PGM key again.
2. To move the display window from row to row, (up and down) use the Up and Down keys.

Table 2.1. PCM 70 Preset Programs

Row 0 Chorus & Echo	0.0 CHORUS	0.1 CHORUS ECHOES	0.2 ECHO FLANGE	0.3 STEREO FLANGE	0.4 DOUBLE SLAP
Row 1 Multiband Dlys	1.0 SINGLE DELAY	1.1 DOUBLE DELAY	1.2 PAN DELAY	1.3 CIRCULAR DLYS	1.4 4 VOICE DELAY
Row 2 Res. Chords	2.0 MAJOR CHORD	2.1 MINOR CHORD	2.2 7TH SHARP 11	2.3 DOM 13TH	2.4 RYM IN C BPM
Row 3 Concert Halls	3.0 CONCERT HALL	3.1 LONG HALL	3.2 GYMNASIUM	3.3 N/A	3.4 N/A
Row 4 Rich Chambers	4.0 RICH CHAMBER	4.1 SMALL ROOM	4.2 TILED ROOM	4.3 GATED CHAMBER	4.4 INF REVERB
Row 5 Rich Plates	5.0 RICH PLATE	5.1 SMALL PLATE	5.2 GATED PLATE	5.3 N/A	5.4 N/A
Row 6 MIDI Effects	6.0 MIDI ECHO BPM	6.1 CASCADE BPM	6.2 FILTR PAN BPM	6.3 MIDI CHR D BPM	6.4 MIDI SLAP BPM
Row 7 Control Progs.	7.0 CONTROL PGM	7.1 COR REG TABLE	7.2 N/A	7.3 N/A	7.4 N/A

3. To move the display window from column to column (side to side) use the 0-9 keys.
4. To select a specific program for use; 4.2 TILED ROOM, for example, use the Up and Down keys to move to row 4, and then press the 2 key to select column 2.
5. Press the LOAD key to activate the selected program. The display window reads

LOADING PROGRAM

and then displays the program name. Whatever program was active previously will halt and the new program will begin processing audio after a very brief pause.

Note: When you select a new program, the previously loaded program will continue to process audio until you actually load the new program by pressing the LOAD key.

Using The Parameter Mode

The sounds of the preset programs supplied with the PCM 70 cover an astounding range of possibilities, but sooner or later you will want to alter the sounds of the programs to more perfectly fit your requirements. Each program in the PCM 70 contains a set of parameters that can be edited to create a sound uniquely your own.

The parameters are laid out in an arrangement of rows and columns, exactly like the program directory discussed above. Tables 4.1 through 4.8 in Chapter 4 list the parameters available for each of the programs in the PCM 70.

Entering the Parameter Mode

The PCM 70 is in the parameter mode whenever it is not in the program or register mode; that is, whenever both the PGM and REG LEDs are not lit. To enter the parameter mode, look at the front panel. If the PGM LED is lit, press the PGM key briefly. If the REG LED is lit, press the REG key briefly. The LED key goes out, indicating that the PCM 70 is ready for you to edit parameters.

0.5 SPIM ECHOES	0.6 SWARBLE	0.7 PSYCHO ECHOES	0.8 ECHOES BPM	0.9 CORSENECO BPM
1.5 QUATRO DELAYS	1.6 FILTERED DLYS	1.7 SHUFFLE BPM	1.8 BOUNCING BPM	1.9 N/A
2.5 RYM C MIN BPM	2.6 N/A	2.7 N/A	2.8 N/A	2.9 N/A
3.5 N/A	3.6 N/A	3.7 N/A	3.8 N/A	3.9 N/A
4.5 N/A	4.6 N/A	4.7 N/A	4.8 N/A	4.9 N/A
5.5 N/A	5.6 N/A	5.7 N/A	5.8 N/A	5.9 N/A
6.5 MIDI CT HALL	6.6 MIDI INF RVB	6.7 N/A	6.8 N/A	6.9 N/A
7.5 N/A	7.6 N/A	7.7 N/A	7.8 N/A	7.9 N/A

Editing Parameters

To get you started with parameters, let's load program 4.2 TILED ROOM and edit two parameters that are frequently adjusted. The first parameter we'll edit is 0.0 MIX. MIX sets the ratio of dry (direct) sound to wet (processed) sound at the PCM 70 main outputs.

1. Select and Load program 4.2 TILED ROOM.
2. Put the PCM 70 in the parameter mode by pressing the PGM key briefly. The LEDs on the PGM and REG keys will both be unlit.
3. Experiment with the Up, Down and 0-9 keys. Notice that you can select parameters in the same way that you selected programs.
4. Select parameter 0.0. The display window reads

0.0 MIX 100% WET

5. Turn the Soft Knob counterclockwise, then clockwise. Notice that the MIX value in the display window varies as you turn the Soft Knob.

6. If the PCM 70 is connected to a mixing console, you'll probably want to use the console's controls to set the effects level in the mix, so MIX should be set to 100% wet.
7. If a musical instrument is connected directly to the input of the PCM 70, use MIX to balance the dry and wet sound. Adjust the Soft Knob until the balance sounds right to you.

Another frequently-adjusted parameter is 0.3 SIZE. SIZE sets the apparent size of the acoustic space that the PCM 70 creates.

1. Press the 3 key. The Display Window now reads:

0.3 SIZE 8.5 M
2. Turn the Soft Knob counterclockwise, then clockwise. Note that the SIZE parameter ranges from 5.6 to 32.6 meters.

The techniques you have just learned for adjusting parameters can be used to edit any PCM 70 parameter.

Using the Master Parameters

Many of the PCM 70 programs contain MASTER parameters that simultaneously affect an entire row of parameters. For example, in the Chorus and Echo programs, 2.0 DLY MST (delay master) simultaneously changes the individual delay settings for all six voices. MASTER parameters are always located in column 0.

The LOAD key has a special function when MASTER parameters are selected. Pressing the LOAD key allows you to view each of the parameters controlled by the MASTER. This is useful because you can quickly see the results of the overall changes you are making with the MASTER. Let's experiment.

1. Load program 0.0 CHORUS.
2. Enter the parameter mode and select 2.0 DLY MST.
3. Notice that the indicator on the LOAD key is now lit.
4. Press the LOAD key. The V1 DLY parameter now appears in the display. Note the amount of delay currently set.
5. Press the LOAD key again. The V2 DLY parameter now appears in the display window.
6. Adjust the Soft Knob. Note that the V2 DLY value changes.
7. Press the LOAD key repeatedly until the V1 DLY parameter reappears. Note that the V1 DLY amount has also changed.

Using a MASTER parameter in combination with the LOAD key is the most efficient way of adjusting several related parameters.

For even more creative control, you can create a custom MASTER to control any combination of up to ten parameters simultaneously. To learn more about this advanced application, read Chapter 5, *MIDI and the PCM 70*.

Using the Register Mode

The ability to edit programs would be of little use if there was no way to store the edited programs. Not to worry--the PCM 70 has 50 registers available to store edited versions of the preset programs. Registers are organized into a directory, selected, and loaded exactly like the preset programs. Once stored in a register, an edited program will be retained even if power is disconnected from the unit for long periods of time.

To enter the register mode, press the REG key. The LED on the REG key lights, indicating you are in the register mode. When you first receive your PCM 70, the registers will probably be empty and the display window will read

UNUSED

If you try to load an unused register, the display window reads

REGISTER UNUSED

Storing Edited Programs in Registers

To store an edited version of a preset program:

1. Press the REG key once. The LED in the upper left-hand corner of the key will light. This indicates that the PCM 70 is in the register selection mode. Names of stored registers appear in the display window.

2. Use the Up, Down, and 0-9 keys to locate an unused register.
3. Press and hold the REG key. While holding the REG key, press the LOAD key. The display window reads

REGISTER STORED

Note: Before you store a program, go into the parameter mode and select the parameter you adjust most often. Later, when you enter the parameter mode after loading the register, that parameter will be automatically selected and appear in the display window.

Loading Edited Programs from Registers

1. Use the Up, Down, and 0-9 keys to select a register to load.
2. Press the LOAD key. The Display Window reads

LOADING REGISTER

Naming Registers

After it is stored, the edited program will still have the same name as the original program. To avoid the possibility of confusion, the PCM 70 allows you to rename programs. The name of a program or register is always stored as parameter 0.9. Like any other parameter, the names of the *programs* cannot be permanently changed, but names of *registers* can be changed as often as you like. To change the name of a register:

1. Press the REG key briefly. The LED in the upper left-hand corner of the REG key should go out, indicating that the PCM 70 is ready to edit parameters.
2. Select parameter 0.9.

3. Press the LOAD key. The first character of the program name should begin to blink.
4. Adjust the Soft Knob until the first character of the new name appears in the display. In addition to the characters A-Z, you can select a numeral from 0-9, or a blank space.
5. When you have selected a character, press the LOAD key once. The display will advance to the next character. Continue entering characters until the display is full (enter blank characters at the end of the name if it is shorter than 13 characters).
6. When you are finished editing the name, press the REG key. The LED in the upper left-hand corner of the REG key lights.
7. To permanently store the new name, press and hold the REG key. While holding the REG key, press the LOAD key. The register is stored and the new name appears in the display window.

Note: In this example, we asked you to first store an edited program, change its name, and then store it again. Actually, there is no reason why you can't change the program's name *before* you store it in a register.

Register Protection

Setting up registers to meet your personal requirements can represent a considerable investment in time and effort. To reduce the possibility of accidental loss of the contents of these registers, the PCM 70 includes a memory protection feature. When this feature is turned on, the PCM 70 will not allow you to erase the contents of a register by overwriting it with a new program. However,

unused registers remain available for storage of new programs. This allows you to protect registers from accidental loss of data without undue inconvenience.

To activate memory protection:

1. Load 7.0 CONTROL PGM.
2. Enter the parameter mode and select 0.1 M PROTECT (memory protection).
3. Rotate the Soft Knob until the display reads

M PROTECT ON

The memory protection will remain in effect until this parameter is changed back to

M PROTECT OFF

Setting Audio Levels

To obtain the best possible performance from the PCM 70, you should set the input and output audio levels with care.

1. Set the Input and Output Level push-buttons on the rear panel to the position that best matches the other components in your system.
2. Apply an input signal at a level that you typically use.

3. While watching the HEADROOM display, adjust the front panel INPUT control so that all the LEDs except the red 0 dB indicator flash on peaks. A flashing red LED indicates that there is no more headroom available before clipping or overload occurs. The input signal is too high, and its level should be reduced.
4. Next, set the MIX parameter as described on page 2-4.

A Good Start

You should now know how to set audio levels, load a preset program, edit parameters, store the edited program in a register, and recall it at a later date. This is all the information you need to begin using the PCM 70 effectively. Feel free to experiment--you can't hurt anything!

When you encounter a parameter you don't understand, refer to Chapter 3, *What the Parameters Do* for a description. Of course, not everything can be discovered by experimentation. When you are ready to find out more about how to use the programs stored in the PCM 70, read to Chapter 4, *Using the PCM 70 Preset Programs*.

Introduction

This chapter describes (in alphabetical order) each of the parameters available in the PCM 70. **Effects parameters are listed first, then reverb parameters, and finally control parameters.** No single program has all of the parameters described in this section--see the tables in Chapter 4, *Using the Preset Programs* for the location and availability of parameters for each program.

Effects Parameters

CHORUSING

CHORUSING modulates the time delays in both effects and reverb programs. It controls the rate of the chorus effect (depth is a preset value). At moderate settings it adds richness to the sound of nearly any instrument and creates the illusion of added voices. In larger amounts it produces flanging and pitch-twisting effects.

CHORUS (MODE)

This parameter is only available for the Row 0 Chorus and Echo programs which feature multiple voices (delays). It determines if CHORUSING is active, how many voices are chorused, and whether a triangle or sine wave LFO is used.

With the Soft Knob fully counterclockwise, the display window reads

CHORUS OFF

If the Soft Knob is turned one click in the clockwise direction, the display window reads

CHORUS 1 VC S

This indicates that chorusing is on for the first voice only, using a sine wave LFO. As you continue turning the Soft Knob in the clockwise direction, chorusing is added to voices 2, 3, 4, 5, and 6. Note that by only chorusing voices you are actually using, you increase the effect. When you pass voice 6, the display window returns to voice 1, but notice that the LFO changes from a sine wave to a triangle wave:

CHORUS 1 VC T

DIFFUSION

DIFFUSION controls the density of echoes. High levels of diffusion thicken or smear the echoes. This is especially noticeable on material with sharp transients.

DLY MST (Delay Master)

DLY MST provides simultaneous changes in the delay times for all voices. To see how adjusting the master affects the individual voices, press the LOAD key to sequentially view each voice.

FDBK

See V1 FDBK.

FDBK MST (Feedback Master)

FDBK MST is available for programs which have a feedback level control for each voice. It allows simultaneous changes in feedback level for all voices.

To see how adjusting the master affects the individual voices, press the **LOAD** key to sequentially view each voice.

FX ADJ (Effects Level Adjust)

FX ADJ controls the level of the processed (wet) signal before it is mixed with the dry signal (if any) and sent to the audio outputs. The range of this parameter is between -90 dB and +12 dB. **FX ADJ** is inactive when the PCM 70 is in the bypass mode, so it's a good idea to compare the levels with the bypass on and off while editing this parameter. Adjust it until the audio level sounds the same with bypass on and off.

HC (High-Frequency Cutoff)

HC sets the high-frequency cutoff (frequency) of a low-pass filter. Some programs offer separate left and right **HC** parameters, and others have a single **HC** parameter for both channels.

HC MST (High-Frequency Cutoff Master)

HC MST allows simultaneous adjustment of all **HC** parameters in multi-voice programs.

LC (Low-Frequency Cutoff)

LC sets the low-frequency cutoff of a high-pass filter.

LC MST (Low-Frequency Cutoff Master)

The **LC MST** allows simultaneous adjustment of the low-frequency cutoff (frequency) for multi-voice programs.

LVL

See **V1 LVL**.

LVL MST (Level Master)

The **LVL MST** controls the overall level in programs which have more than one voice. This permits simultaneous changes in all

voice levels without altering the balance between individual voices.

MIX

MIX controls the ratio of dry vs. wet signal present at the PCM 70's outputs. When the PCM 70 is patched into a console or instrument amplifier through an auxiliary or effects loop, this control should always be set to 100% wet. When an instrument is plugged directly into the PCM 70, a setting between 45 and 65% is a good starting point.

PAN MST (Pan Master)

PAN MST provides simultaneous control over the panning of all voices in a program, and shifts the stereo image from left to right.

PATCH

One of the PCM 70's most powerful features is its MIDI patching capability. Each program has ten different patches which allow controls and events on keyboards, synths, and other MIDI devices to dynamically control the settings of up to ten different PCM 70 parameters--individually or together, and in real time. You can use performance events (such as last note played, after touch, or velocity) or controls (such as volume, pitch bender, mod control, footpedal, and other controls and switches). For a complete discussion of the **PATCH** parameter, see Chapter 5, *MIDI and the PCM 70*.

PCH MST (Pitch Master)

PCH MST provides simultaneous control over the pitches of all voices in the row 2 resonant chord programs. This allows a change of key without altering the relationship between individual voices.

PDL MST (Predelay Master)

PDL MST allows the predelay settings for all voices to be changed simultaneously.

RATE BPM (Rate in Beats Per Minute)

In programs which include BPM in their program name, the DLY MST parameter has been replaced with a RATE BPM parameter. This makes it very easy to match the tempo of rhythmic effects like echoes and resonant chords to the tempo of the music being sent to the PCM 70. For a different effect, try setting RATE BPM to twice or half the actual tempo of the music.

RESN

See V1 RESN.

RESN MST (Resonance Master)

RESN MST allows the resonance setting for all voices to be changed simultaneously.

SOFT KNOB

The PATCH parameter (described above) can assign one or more parameters to be controllable from the Soft Knob, instead of a MIDI device or event. While you probably won't want to use this capability to control a single parameter, it is very useful when you need to alter several parameters simultaneously. For a complete discussion of the SOFT KNOB and PATCH parameters, read Chapter 5, *MIDI and the PCM 70*.

V1 DLY

In programs with multiple delay voices, this parameter sets the delay time (in milliseconds) for the first voice. In BPM programs, DLY is set as a fraction of a single beat. The smallest fraction is 1/24th of a beat.

V1 FDBK (Voice 1 Feedback)

V1 FDBK controls the level and polarity of signals recirculated back to the input for the first voice in a program. Some programs have feedback controls for all voices, others only have them for two of the available voices. A FDBK MST (Feedback Master) con-

trol (described above) allows simultaneous changes in all feedback parameters.

Increasing the amount of feedback can create interesting resonant effects, but be careful--if feedback is set too high, runaway feedback (oscillation) can occur. This does not indicate a problem with the PCM 70. Reduce the level of feedback and the oscillation will stop.

V1 HC (Voice 1 High-Frequency Cutoff)

V1 HC sets the high-frequency cutoff frequency of a low-pass filter for the first voice. There are as many HC controls as there are voices. The HC MST control (described above) allows simultaneous changes in all high-frequency cutoff frequencies, without altering the relationship between the voices.

V1 LC (Voice 1 Low-Frequency Cutoff)

V1 LC sets the low-frequency cutoff frequency of a 6 dB/octave low-pass filter. Most programs have a low-frequency cutoff control for each voice. An LC MST parameter (described above) allows simultaneous changes in all low-frequency cutoffs without altering the relationship between individual voices.

V1 LVL (Voice 1 Level)

V1 LVL adjusts the level for the first voice in a program. The voice can be turned completely off, full on, or anywhere in between, in 1/2 dB increments. There are as many voice level controls as there are voices. The LVL MST control (described above) allows simultaneous changes in all voice levels without altering the level balance between individual voices.

V1 PAN (Voice 1 Pan)

V1 PAN positions the output for voice one full left, full right, centered, or anywhere in between. Each voice can be panned independently, so some rather startling stereo effects

are possible. A PAN MST control (described above) allows simultaneous changes in overall image position.

V1 PDL (Voice 1 Predelay Time)

V1 PDL adjusts predelay time for the first voice, in milliseconds. Each voice has its own voice delay time control, and a PDL MST (Predelay Master) control (described above) permits simultaneous control over all voices.

V1 PITCH (Voice 1 Pitch)

V1 PITCH tunes the first voice to a specific note and octave. Each voice has its own pitch control. A PCH MST control allows the program to be tuned to a new key, without altering the relationship between individual voices.

V1 RESN (Voice 1 Resonance)

V1 RESN sets the amount and polarity of feedback for the first voice. Each voice has its own resonance control.

Reverb Parameters

ATTACK

ATTACK sets the sharpness of the initial response to an input signal. High settings cause an explosive sound, while low settings cause the sound to build up more slowly with time. ATTACK only affects the level of sound within the first 50 milliseconds.

CHORUSING

CHORUSING randomizes delay times and introduces modulation to make reverberation sound less metallic. Increasing CHORUSING increases the rate of modulation. Because CHORUSING can cause pitch variation, this parameter should be set with care when using sources with very little pitch wobble

(like guitar and piano). A good practice is to increase the setting until pitch wobble becomes noticeable, and then lower it slightly.

DECAY OPT (Decay Optimization)

DECAY OPT alters program characteristics in response to changes in input level to make reverb decay sound more natural. This parameter should normally be set to ON. However, with certain types of source material (e.g., soft low-frequency tones from a synthesizer) audible clicks may occur during level changes. If clicks are heard, set DECAY OPT to OFF.

DEFINITION

DEFINITION affects the echo density build-up rate during the latter part the decay period. With DEFINITION set to 0, the rate is determined by the program. Raising DEFINITION causes the sound to become choppy--the decrease in density of the echoes creates increasingly distinct, repetitive echo trails.

DIFFUSION

DIFFUSION controls the degree to which echo density increases over time. High DIFFUSION settings result in high initial buildup of echo density, and low settings cause low initial buildup. After the initial period (in which echo buildup is controlled by DIFFUSION), density continues to rise at a preset rate determined by the program.

DLY MST (Delay Master)

DLY MST allows simultaneous adjustment of the early reflection delay times.

FX ADJ (Effects Level Adjust)

FX ADJ controls the level of the processed (wet) signal before it is mixed with the dry signal (if any) and sent to the audio outputs. The range of this parameter is between -90 dB and +12 dB. FX ADJ is inactive when

the PCM 70 is in the bypass mode, so it's a good idea to compare the levels with the bypass both on and off while editing this parameter. Adjust it until the audio level sounds the same with bypass on and off. Some adjustment of the Input Level Control may also be necessary.

GATE

GATE sets the time delay in switching between running reverb time and stopped reverb time.

HC (High-Frequency Cutoff)

HC sets the frequency above which a 6 dB/octave low-pass filter attenuates the processed signal. It attenuates both preechoes and reverberant sound. High frequencies are often rolled off with this parameter, resulting in more natural-sounding reverberation.

L RFL DB (Left Early Reflection Levels)

For each of the L RFL MS parameters, there is a corresponding L RFL DB parameters. L RFL DB sets the level (amplitude) for one of the left channel early reflections.

Early reflections can best be understood by visualizing a stage where the early reflections are the sounds emanating from the rear and side stage walls directly after the sound from the stage. Usually the rear stage wall reflection is earlier and louder than those from the two side walls. The early reflection parameters change the perceived reflecting surfaces surrounding the source.

L RFL MS (Left Early Reflection Delay Time)

L RFL MS sets the delay time in ms for the one of the left channel early reflections. The L RFL MS delay time parameters can be set independently of each other.

LVL MST (Level Master)

LVL MST allows simultaneous changes in the early reflection levels without altering the relationship between individual reflections.

MIX

MIX controls the ratio of dry vs. wet signal present at the PCM 70's outputs. When the PCM 70 is patched into a console through an auxiliary or effects loop, this control should always be set to 100% wet. When an instrument is plugged directly into the PCM 70, a setting between 45 and 65% is a good starting point for experimentation with this parameter.

PATCH

One of the PCM 70's most powerful features is its MIDI patch capability. Each program has ten different patches which allow controls and events on keyboards, synths, and other MIDI devices to dynamically control the settings of up to ten different PCM 70 parameters--in real time. You can use performance events (such as last note played, after touch, or velocity) or controls (such as volume, pitch bender, mod control, foot-pedal, and other controls). For a complete discussion of the PATCH parameter, see Chapter 5, *MIDI and the PCM 70*.

PDELAY (Predelay)

PDELAY sets the amount of time that elapses between input and the onset of reverberation. Under natural conditions, the amount of predelay depends on the size and construction of the acoustic space and the relative position of the sound source and the listener(s). PDELAY duplicates this phenomenon and is used to create a sense of distance and volume within an acoustic space. Relatively long PDELAY settings place the reverberant field *behind* rather than on top of the input material. Extremely long PDELAY settings produce unnatural sounds that often prove quite interesting.

A sense of continuity between source and reverb is maintained up to around 40 ms of predelay, after which the sound begins to separate into distinct patterns; however, large values of predelay can effectively give the impression of large size if early reflections are used to fill in the spaces between input and the delayed reverberation.

R RFL DB (Right Early Reflection Level)

The R RFL level parameter is identical to the L RFL level parameter discussed above, except that it controls early reflections for the right channel instead of the left.

R RFL MS (Right Early Reflection Delay Time)

The R RFL MS delay parameter is identical to the L RFL MS delay parameter discussed above, except that it controls early reflections for the right channel instead of the left.

REV TIME (Reverb Time)

Unlike the other reverb programs in the PCM 70, 4.4 INFINITE REVERB TIME has a single reverb decay time--REV TIME. This simplifies use of the infinite reverb feature. To activate infinite reverb, simply set REV TIME to its highest level. Whatever signal was present during the transition from normal reverb to infinite reverb will be sustained indefinitely.

RT HC (Reverberation Time High-Frequency Cutoff)

RT HC sets the frequency above which sounds decay at a progressively faster rate.

RT LOW (Low-Frequency Running Reverberation Time)

RT LOW sets the reverberation time for low-frequency signals.

RTL STOP (Low-frequency Stopped Reverberation Time)

RTL Stop sets the reverberation time for low-frequency signals in the absence of input--i.e., during pauses between signals input into the PCM 70.

RT Mid (Mid-Frequency Running Reverberation Time)

RT MID sets the reverberation time for mid-frequency signals.

RTM STOP (Mid-Frequency Stopped Reverberation Time)

RTM STOP sets the reverberation time for mid-frequency signals in the absence of input--i.e., during pauses between signals input into the PCM 70.

SIZE (Room Size)

SIZE sets the apparent size of the acoustic space produced by the PCM 70 (essentially the longest dimension, measured in meters). Note: Changing SIZE while a signal is present will result in a momentary muting of the reverb signal.

SOFT KNOB

The PATCH parameter (described above) can assign one or more parameters to be controllable from the Soft Knob, instead of a MIDI device or event. While you probably won't want to use this capability to control a single parameter, it is very useful when you wish to alter several parameters simultaneously. For a complete discussion of the SOFT KNOB and PATCH parameters, read Chapter 5, *MIDI and the PCM 70*.

XOVER (Crossover Frequency)

XOVER sets the frequency at which the transition from low-frequency reverb time to mid-frequency reverb time takes place.

Control Parameters

AUTOLOAD

When AUTOLOAD is ON, every time a program is selected with the 0-9 keys, it is automatically loaded and used. When AUTOLOAD is OFF, programs must be manually loaded after selection. When shipped from Lexicon, AUTOLOAD is set to OFF. Be very cautious about editing programs while in the AUTOLOAD mode. It is very easy to erase your changes by accident.

M PROTECT (Memory Protect)

When M PROTECT is ON, the PCM 70 will not allow you to erase the contents of a register by overwriting it with a new program. Unused registers remain usable. This allows you to protect registers from accidental loss of data without undue inconvenience.

MIDI CHNL (MIDI Channel Select)

MIDI CHNL sets the MIDI Receive and Transmit Channel for the PCM 70. When OMNI MODE is OFF, only MIDI information received on this channel will be processed. For more information on MIDI and the PCM 70, read Chapter 5, *MIDI and the PCM 70*.

OMNI MODE

When OMNI MODE is ON, information received on any of the 16 MIDI channels will be processed. When OMNI MODE is OFF, MIDI information will be processed only if it is received on the channel set with the MIDI CHNL parameter. In all but the simplest systems, OMNI MODE should usually be set to OFF to avoid undesired program changes and other unexpected results. For more information on MIDI and the PCM 70, read Chapter 5, *MIDI and the PCM 70*.

PGM CHNG (Program Change Mode)

This parameter has three settings--OFF, FIX, and TABLE. When PGM CHNG is set to OFF, program change messages received from another MIDI device will be ignored.

When PGM CHNG is set to FIX, program change messages received from another MIDI device will be followed literally. Program change messages from 0 to 49 will load *user registers* 0.0 to 4.9. Program change messages 50 and up will select and load *preset programs* 0.0 and up. So, for example, if you select program 23 on a synthesizer, register 2.3 will be selected and loaded on the PCM 70. If you select program 64 on a synthesizer, preset program 1.4 will be selected and loaded on the PCM 70.

When PGM CHNG is set to TABLE, program change messages received from another MIDI device will be looked up on the Corresponding Register Table. The corresponding register or preset will then be loaded. This makes optimal use of the PCM 70's registers by allowing several synthesizer presets to be assigned to a single PCM 70 register. For more information on the Corresponding Register Table read Chapter 5, *MIDI and the PCM 70*.

REG CLEAR (Register Clear)

REG CLEAR allows the complete erasure of a user register. Select the register to be cleared with the Soft Knob, and press the LOAD key to erase its contents.

RESET MIDI

RESET MIDI restores the PCM 70's record of the values of all the MIDI controllers to their power-on condition. Select RESET MIDI and press the LOAD key.

Using the Preset Programs

Introduction

This chapter describes the effects and reverberation programs supplied in the PCM 70. The programs are organized as shown in Table 2.1 in Chapter 2. In general, all of the programs in a single row are closely related, sharing a common set of variable parameters. What makes the programs within a row sound different from one other are the values assigned to the parameters.

Row 0 - Chorus and Echo Programs

In contemporary production, much attention is given to achieving a quality of fullness in the sound. The Chorus and Echo programs are extremely useful in increasing the fullness or richness of musical parts. It is very easy to start with a simple chorus effect and add repeats by increasing the delay time of one of the voices.

The Chorus and Echo programs in row 0 have six separately adjustable voices--allowing the PCM 70 to sound like a rack of six digital delay lines. Each voice has its own independently-adjustable level control, delay time, feedback, and panning control. Sine Wave or Triangle wave chorusing can be selected for one or more of the voices.

Notes on the Parameters

All the parameters (and their locations) available for the Chorus and Echo programs are shown in Table 4.1.

The key to the sound of the Chorus and Echo programs is the 0.3 CHORUSING parameter. CHORUSING affects all six voices at once, and it varies the intensity of the

random delay variation (pitch shifting). CHORUSING should be set with care to avoid pitch shifting, detuning, and unpleasant artifacts, unless these are desired. A good approach is to increase the CHORUSING parameter until detuning or noise becomes audible, and then reduce it slightly.

The maximum delay variation for the CHORUSING parameter is 7.5 ms. If you use CHORUSING to produce interference effects between voices, their delays should be set to within 7 ms of each other.

The maximum delay time available in the Chorus and Echo programs is 432 ms. When the DIFFUSION parameter is in use, it adds between 4 and 20 ms of delay to the delay times shown in the display window. The exact amount of extra delay depends on the setting of DIFFUSION. *This extra delay can be completely removed by setting DIFFUSION to 0.* Delay times shown in the display window will then be accurate.

As with a traditional digital delay line, the delay times you select have a profound effect on the sound produced. Very short delays often affect the tone quality of the sound through phase cancellation. Longer delays are heard as discrete repeats or slaps. This is useful for either doubling or true slapback echoes. For doubling, try delay times between 15 and 50 ms, with slightly different delay times on several voices. Pan the voices to different locations for a thicker, more interesting sound.

For slapback echoes, try delays between 50 and 150 ms. Percussive material accentuates the discreteness of longer delays, but this can be smoothed out with 0.6 DIFFUSION. Vocals and other nonpercussive material can use longer delay times and lower diffusion.

Table 4.1. Parameters - Row 0 Chorus and Echo Programs

0.0 MIX	0.1 FX ADJ	0.2 SOFT KNOB	0.3 CHORUSING	0.4 CHORUS MODE
1.0 LVL MST	1.1 V1 LVL	1.2 V2 LVL	1.3 V3 LVL	1.4 V4 LVL
2.0 DLY MST	2.1 V1 DLY	2.2 V2 DLY	2.3 V3 DLY	2.4 V4 DLY
3.0 FDBK MST	3.1 V1 FDBK	3.2 V2 FDBK	3.3 V3 FDBK	3.4 V4 FDBK
4.0 PAN MST	4.1 V1 PAN	4.2 V2 PAN	4.3 V3 PAN	4.4 V4 PAN
5.0 PATCH	5.1 PATCH	5.2 PATCH	5.3 PATCH	5.4 PATCH

Table 4.2. Parameters - Row 1 Multiband Delay Programs

0.0 MIX	0.1 FX ADJ	0.2 SOFT KNOB	0.3 DIFFUSION	0.4 V1 FDBK
1.0 LVL MST	1.1 V1 LVL	1.2 V2 LVL	1.3 V3 LVL	1.4 V4 LVL
2.0 DLY MST	2.1 V1 DLY	2.2 V2 DLY	2.3 V3 DLY	2.4 V4 DLY
3.0 LC MST	3.1 V1 LC	3.2 V2 LC	3.3 V3 LC	3.4 V4 LC
4.0 HC MST	4.1 V1 HC	4.2 V2 HC	4.3 V3 HC	4.4 V4 LC
5.0 PAN MST	5.1 V1 PAN	5.2 V2 PAN	5.3 V3 PAN	5.4 V4 PAN
6.0 PATCH	6.1 PATCH	6.2 PATCH	6.3 PATCH	6.4 PATCH

Table 4.3. Parameters - Row 2 Resonant Chord Programs

0.0 MIX	0.1 FX ADJ	0.2 SOFT KNOB	0.3 V3 FDBK	0.4 V6 FDBK
1.0 LVL MST	1.1 V1 LVL	1.2 V2 LVL	1.3 V3 LVL	1.4 V4 LVL
2.0 PCH MST	2.1 V1 PITCH	2.2 V2 PITCH	2.3 V3 PITCH	2.4 V4 PITCH
3.0 RESN MST	3.1 V1 RESN	3.2 V2 RESN	3.3 V3 RESN	3.4 V4 RESN
4.0 PDL MST	4.1 V1 PDL	4.2 V2 PDL	4.3 V3 PDL	4.4 V4 PDL
5.0 PAN MST	5.1 V1 PAN	5.2 V2 PAN	5.3 V3 PAN	5.4 V4 PAN
6.0 PATCH	6.1 PATCH	6.2 PATCH	6.3 PATCH	6.4 PATCH

Table 4.4. Parameters - Row 3 Concert Hall Programs

0.0 MIX	0.1 FX ADJ	0.2 SOFT KNOB	0.3 SIZE	0.4 GATE
1.0 RT LOW	1.1 RT MID	1.2 XOVER	1.3 RT HC	1.4 RTL STOP
2.0 DIFFUSION	2.1 ATTACK	2.2 DEFINITION	2.3 N/A	2.4 N/A
3.0 LVL MST	3.1 L1 RFL DB	3.2 L2 RFL DB	3.3 R1 RFL DB	3.4 R2 RFL DB
4.0 DLY MST	4.1 L1 RFL MS	4.2 L2 RFL MS	4.3 R1 RFL MS	4.4 R2 RFL MS
5.0 PATCH	5.1 PATCH	5.2 PATCH	5.3 PATCH	5.4 PATCH

Table 4.5. Parameters - Row 4 Rich Chamber Programs

0.0 MIX	0.1 FX ADJ	0.2 SOFT KNOB	0.3 SIZE	0.4 GATE
1.0 RT LOW	1.1 RT MID	1.2 XOVER	1.3 RT HC	1.4 RTL STOP
2.0 DIFFUSION	2.1 ATTACK	2.2 DEFINITION	2.3 N/A	2.4 N/A
3.0 LVL MST	3.1 L1 RFL DB	3.2 L2 RFL DB	3.3 L3 RFL DB	3.4 R1 RFL DB
4.0 DLY MST	4.1 L1 RFL MS	4.2 L2 RFL MS	4.3 L3 RFL MS	4.4 R1 RFL MS
5.0 PATCH	5.1 PATCH	5.2 PATCH	5.3 PATCH	5.4 PATCH

Table 4.6. Parameters - 4.4 INF REVERB Program

0.0 MIX	0.1 FX ADJ	0.2 SOFT KNOB	0.3 SIZE	0.4 REV TIME
1.0 DIFFUSION	1.1 ATTACK	1.2 DEFINITION	1.3 N/A	1.4 N/A
2.0 LVL MST	2.1 L1 RFL DB	2.2 L2 RFL DB	2.3 L3 RFL DB	2.4 R1 RFL DB
3.0 DLY MST	3.1 L1 RFL MS	3.2 L2 RFL MS	3.3 L3 RFL MS	3.4 R1 RFL MS
4.0 PATCH	4.1 PATCH	4.2 PATCH	4.3 PATCH	4.4 PATCH

Table 4.7. Parameters - Row 5 Rich Plate Programs

0.0 MIX	0.1 FX ADJ	0.2 SOFT KNOB	0.3 SIZE	0.4 GATE
1.0 RT LOW	1.1 RT MID	1.2 XOVER	1.3 RT HC	1.4 RTL STOP
2.0 DIFFUSION	2.1 ATTACK	2.2 DEFINITION	2.3 N/A	2.4 N/A
3.0 LVL MST	3.1 L1 RFL DB	3.2 L2 RFL DB	3.3 L3 RFL DB	3.4 R1 RFL DB
4.0 DLY MST	4.1 L1 RFL MS	4.2 L2 RFL MS	4.3 L3 RFL MS	4.4 R1 RFL MS
5.0 PATCH	5.1 PATCH	5.2 PATCH	5.3 PATCH	5.4 PATCH

Table 4.8. Parameters - Row 7 Control Program

0.0 AUTO LOAD	0.1 M PROTECT	0.2 REG CLEAR	0.3 N/A	0.4 N/A
1.0 MIDI CHNL	1.1 OMNI MODE	1.2 PGM CHNG	1.3 RESET MIDI	1.4 N/A

0.5	HC	0.6	DIFFUSION	0.7	N/A	0.8	N/A	0.9	NAME
1.5	V5 LVL	1.6	V6 LVL	1.7	N/A	1.8	N/A	1.9	N/A
2.5	V5 DLY	2.6	V6 DLY	2.7	N/A	2.8	N/A	2.9	N/A
3.5	V5 FDBK	3.6	V6 FDBK	3.7	N/A	3.8	N/A	3.9	N/A
4.5	V5 PAN	4.6	V6 PAN	4.7	N/A	4.8	N/A	4.9	N/A
5.5	PATCH	5.6	PATCH	5.7	PATCH	5.8	PATCH	5.9	PATCH

0.5	V2 FDBK	0.6	N/A	0.7	N/A	0.8	N/A	0.9	NAME
1.5	V5 LVL	1.6	V6 LVL	1.7	N/A	1.8	N/A	1.9	N/A
2.5	V5 DLY	2.6	V6 DLY	2.7	N/A	2.8	N/A	2.9	N/A
3.5	V5 LC	3.6	V6 LC	3.7	N/A	3.8	N/A	3.9	N/A
4.5	V5 HC	4.6	V6 HC	4.7	N/A	4.8	N/A	4.9	N/A
5.5	V5 PAN	5.6	V6 PAN	5.7	N/A	5.8	N/A	5.9	N/A
6.5	PATCH	6.6	PATCH	6.7	PATCH	6.8	PATCH	6.9	PATCH

0.5	HC L	0.6	HC R	0.7	N/A	0.8	N/A	0.9	NAME
1.5	V5 LVL	1.6	V6 LVL	1.7	N/A	1.8	N/A	1.9	N/A
2.5	V5 PITCH	2.6	V6 PITCH	2.7	N/A	2.8	N/A	2.9	N/A
3.5	V5 RESN	3.6	V6 RESN	3.7	N/A	3.8	N/A	3.9	N/A
4.5	V5 PDL	4.6	V6 PDL	4.7	N/A	4.8	N/A	4.9	N/A
5.5	V5 PAN	5.6	V6 PAN	5.7	N/A	5.8	N/A	5.9	N/A
6.5	PATCH	6.6	PATCH	6.7	PATCH	6.8	PATCH	6.9	PATCH

0.5	PDELAY	0.6	HC	0.7	DECAY OPT	0.8	CHORUSING	0.9	NAME
1.5	RTM STOP	1.6	N/A	1.7	N/A	1.8	N/A	1.9	N/A
2.5	N/A	2.6	N/A	2.7	N/A	2.8	N/A	2.9	N/A
3.5	N/A	3.6	N/A	3.7	N/A	3.8	N/A	3.9	N/A
4.5	N/A	4.6	N/A	4.7	N/A	4.8	N/A	4.9	N/A
5.5	PATCH	5.6	PATCH	5.7	PATCH	5.8	PATCH	5.9	PATCH

0.5	PDELAY	0.6	HC	0.7	DECAY OPT	0.8	N/A	0.9	NAME
1.5	RTM STOP	1.6	N/A	1.7	N/A	1.8	N/A	1.9	N/A
2.5	N/A	2.6	N/A	2.7	N/A	2.8	N/A	2.9	N/A
3.5	R2 RFL DB	3.6	R3 RFL DB	3.7	N/A	3.8	N/A	3.9	N/A
4.5	R2 RFL MS	4.6	R3 RFL MS	4.7	N/A	4.8	N/A	4.9	N/A
5.5	PATCH	5.6	PATCH	5.7	PATCH	5.8	PATCH	5.9	PATCH

0.5	PDELAY	0.6	HC	0.7	N/A	0.8	N/A	0.9	NAME
1.5	N/A	1.6	N/A	1.7	N/A	1.8	N/A	1.9	N/A
2.5	R2 RFL DB	2.6	R3 RFL DB	2.7	N/A	2.8	N/A	2.9	N/A
3.5	R2 RFL MS	3.6	R3 RFL MS	3.7	N/A	3.8	N/A	3.9	N/A
4.5	PATCH	4.6	PATCH	4.7	PATCH	4.8	PATCH	4.9	PATCH

0.5	PDELAY	0.6	HC	0.7	DECAY OPT	0.8	N/A	0.9	NAME
1.5	RTM STOP	1.6	N/A	1.7	N/A	1.8	N/A	1.9	N/A
2.5	N/A	2.6	N/A	2.7	N/A	2.8	N/A	2.9	N/A
3.5	R2 RFL DB	3.6	R3 RFL DB	3.7	N/A	3.8	N/A	3.9	N/A
4.5	R2 RFL MS	4.6	R3 RFL MS	4.7	N/A	4.8	N/A	4.9	N/A
5.5	PATCH	5.6	PATCH	5.7	PATCH	5.8	PATCH	5.9	PATCH

0.5	N/A	0.6	N/A	0.7	N/A	0.8	N/A	0.9	N/A
1.5	N/A	1.6	N/A	1.7	N/A	1.8	N/A	1.9	N/A

The number of voices used has a marked effect on the sound produced by the Chorus and Echo programs. Generally, the more voices used, the thicker the sound. Phase cancelations between the voices can be used to color the sound, and panning the voices to different positions can create a dramatic sense of dimensionality.

Recirculation of the delays with the FDBK (feedback) parameters in row three forms a resonant comb filter and colors the sound in a pronounced manner. The result can be both interesting and bizarre.

Row 1 - Multiband Delay Programs

The family of seven programs in row one are called Multiband Delays. They feature six separately adjustable voices, each with its own level control, delay time, low and high frequency filters, and pan controls. Voices 1 and 2 have independent feedback controls, and a master diffusion parameter affects all six of the voices.

The maximum delay time available is 936 ms--more than twice that of the Chorus and Echo programs. The Multiband Delay Programs also have individual LC (low-cut) and HC (high-cut) parameters for each voice.

Notes on the Parameters

When the DIFFUSION parameter is in use, it adds between 4 and 20 ms of delay to the delay times shown in the display window. The exact amount of extra delay depends on the setting of DIFFUSION. *This extra delay can be completely removed by setting DIFFUSION to 0.* Delay times shown in the display window will then be accurate.

The parameters (and their locations) available for the Multiband Delay programs are shown in Table 4.2.

Row 2 - Resonant Chord Programs

The family of four programs in row two are called Resonant Chords. These programs are unlike anything that has ever appeared before in an effects processor. Impulsive energy at the input is used to excite six resonant voices (notes). The level, pitch, duration, and high-frequency cutoff of the overtones for each voice are separately controllable. Each voice may be panned independently.

The notes resonate to some degree with any input, but the most effective excitation contains all frequencies, like percussion. Experimentation with electronic drums or a drum machine can produce interesting and original sounds. Other instruments, like synthesizers and guitars may give a quality of tonal ambience in which certain notes rise ethereally out of the background.

Notes on the Parameters

The parameters (and their locations) available for the Resonant Chord programs are shown in Table 4.3.

Row one contains level parameters for each voice. Use these level controls to balance the volume levels of each voice.

If fewer than six voices are required, reduce the level control for one or more voices until the display reads "OFF."

Row two contains pitch controls for each voice. Once a chord is created with the individual pitch controls, PCH MST (pitch master) can quickly change the chord's key.

Row three contains RESN (resonance) parameters for each voice. RESN determines how long the note resonates. These parameters have a zero center, producing increasing amounts of positive resonance when turned in one direction, and increasing amounts of negative resonance when turned in the other. Positive feedback generates all the harmon-

ics of each note, and negative feedback produces only the odd harmonics.

Row four contains PDL (predelay) parameters, which set the timing for each voice. Small amounts of predelay create a sound like chord played together. By gradually increasing predelay with each note, the pulse becomes a strum. Large amounts of predelay give a sound more like a sequence of individual notes being played by a sequencer.

Row five contains PAN parameters for each voice.

Row 3 - Concert Hall Programs

The Concert Hall Programs in Row 3 are reverberation programs which emulate real concert halls. The reverberation is very clean, and designed to remain behind the direct sound--adding ambience, but leaving the source unchanged. These programs have a relatively low initial echo density which builds up gradually over time.

The Concert Hall programs are especially good with classical music. For popular music, they can give separately recorded tracks the sense of belonging to the same performance by putting the whole mix in the context of a real-sounding acoustic space.

Notes on the Parameters

The parameters (and their locations) available for the Concert Hall programs are shown in Table 4.4.

0.8 CHORUSING is unique to the Concert Hall program and may be adjusted to give a more random decay characteristic.

Row 4 - Rich Chamber Programs

The Rich Chamber Programs in row 4 produce an even, relatively dimensionless reverberation, with little change in color as the sound decays. The initial diffusion is similar to the Concert Hall programs, but the sense of space and size is much less obvious.

This characteristic, along with the low color in the decay tail make the Rich Chamber programs useful on a wide range of material. They are especially useful on spoken voice, giving a noticeable increase in loudness with very low color.

Notes on the Parameters

When 2.0 DIFFUSION is set to a low or moderate level, the Rich Chamber programs are useful for classical music, especially piano (with short reverberation times) and organ (with long reverberation times). High diffusion settings produce the sound of a large acoustic chamber and are useful on all types of popular music.

Use 0.3 SIZE to maximize the versatility of the Rich Chamber programs. When set to sizes of 16 meters or less, Rich Chamber is tight and articulate--very useful for dialog and music. Larger sizes (around 60 meters) give an excellent concert hall sound, especially if 2.0 DIFFUSION is set to about 50.

The parameters (and their locations) available for the Rich Chamber programs are shown in Table 4.5.

Infinite Reverb

4.4 INF REVERB (infinite reverb) is slightly different than the other Rich Chamber programs. We have provided a single reverb time control (0.4 REV TIME) to simplify use of the infinite reverb effect. Just turn this control all the way up to INFINITE to activate infinite reverb. To add another sound to the loop, lower the control one or more steps, input the sound, and then immediately return the control to INFINITE.

Early Reflections are also available in INFINITE REVERB, allowing you to have extra delay lines running with the infinite loop.

The parameters (and their locations) available for the Infinite Reverb program are shown in Table 4.6.

Row 5 - Rich Plate Programs

The Rich Plate programs in row 5 mimic the sounds of metal plates, with high initial diffusion, and a relatively bright sound. This makes them a good choice for any type of percussion.

Notes on the Parameters

The parameters (and their locations) available for the Rich Plate programs are shown in Table 4.7.

If 2.0 DIFFUSION is set low, the Rich Plates have a very clear sound that is excellent on vocals, and can be used with the early reflections in rows two and three to create a wide variety of acoustic environments. If 2.0 DIFFUSION is set high, the result is a smooth, dense sound with useful applications in all types of popular music.

When 0.3 SIZE is set at around 16 meters, the sound is dense and tight--ideal for percussion. Larger sizes and longer reverb times are more suitable for vocals and brass.

Row 6 - MIDI Effects Programs

The programs in row 6 are actually programs from the other rows, except that their PATCH parameters are preset to utilize the PCM 70's powerful MIDI control capabilities. We have created patches to controls and events that are available on most popular synthesizers. If your instrument doesn't have one of the controllers mentioned here, you can edit the PATCH parameters to allow use of controllers you *do* have.

In all of the row 6 programs, MIX has been patched for control by the Data Entry Control (available on several MIDI-equipped synthesizers). With the Data Entry Control all the way down, MIX is set to 100%. With the Data Entry Control all the way up, MIX is set to 10%.

Program 6.0 MIDI ECHO BPM is a chorus and echo program. The portamento switch

changes the rhythm of the echoes, and the modulation control adds feedback.

Program 6.1 CASCADE BPM is a resonant chords program. The modulation control adds feedback. The pitch wheel modifies the pitch of the last two notes ± 2 half-steps. The portamento switch changes the rhythm of the echoes.

Program 6.2 FILTR PAN BPM is a multi-band delay program. The modulation control adds feedback. The last note played (event) changes panning from left at low notes to right at high notes.

Program 6.3 MIDI CHR D BPM is a resonant chords program. The modulation control adds feedback. The portamento switch changes the rhythm. The pitch wheel changes the pitch of two of the voices ± 2 half steps. The last note played changes all pitches together.

Program 6.4 MIDI SLAP BPM is a chorus and echo program. The portamento switch changes from a slap echo to a longer rhythm. The modulation wheel adds feedback.

Program 6.5 CONCERT HALL is a concert hall program. The modulation control adjusts reverb time and mix. Aftertouch controls chorusing.

Program 6.6 INF REV is an infinite reverb program. The modulation control adjusts reverb time. The sustenudo pedal controls reverb time also (don't confuse this pedal with the sustain pedal found on many synthesizers).

Row 7 - Control Programs

The programs in row 7 provide some house-keeping capabilities, such as selection of the autoloading mode, memory protection, MIDI mode and channel, and the corresponding register table.

Introduction

The PCM 70 introduces innovative MIDI features and control capabilities that were previously not available in effects processors. While you may discover some applications that we haven't thought of yet, most uses of MIDI will fall into one of six basic categories:

- Connection of two or more PCM 70 units for automatic linked program and register changes
- Automatic selection of a PCM 70 program or register when a program is selected on a synthesizer
- Real time control of up to ten PCM 70 parameters at a time from a remote keyboard or controller, using the PCM 70's PATCH feature
- Automatic program selection and parameter control from a MIDI digital sequence recorder (sequencer)
- Transfer of registers from one PCM 70 to another
- Use of a computer and patch editing software to remotely control the PCM 70 via MIDI System Exclusive messages. Can also store registers in computer.

We'll discuss each of these applications in this chapter, but first, let's cover some typical MIDI installations. It's important to realize that the MIDI connections on the following pages are intended only as general guidelines. You will probably need to modify them to meet your personal requirements.

MIDI Connections

To link two PCM 70's together for simultaneous loading of programs and registers, connect the MIDI OUT from one unit to the MIDI IN of another unit, as shown in Figure 5.1. As with any MIDI connection, use only standard MIDI cables and keep their length as short as possible to avoid possible data errors. 15 meters is generally accepted as the longest length that should be used.

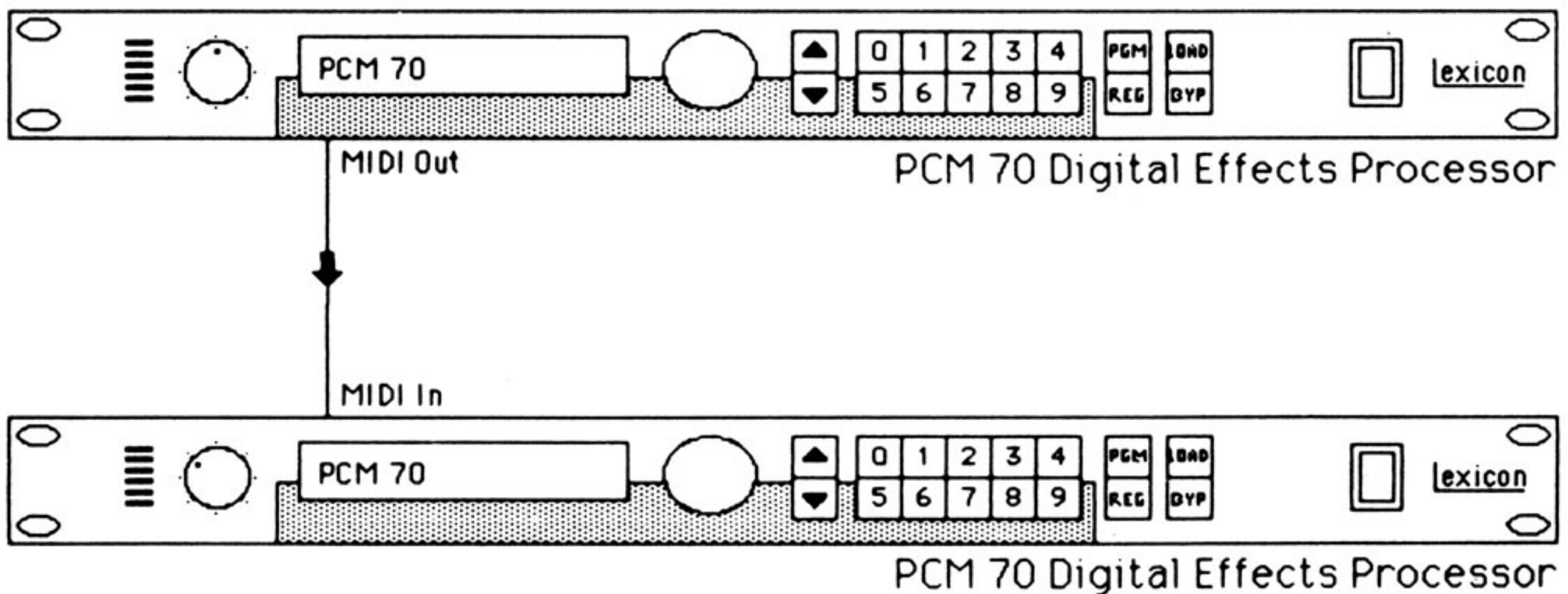

Figure 5.1. Linking two PCM 70 units

The PCM 70 is compatible with virtually all MIDI keyboards, controllers, synthesizers, and drum machines. Simply connect the MIDI Out from the MIDI instrument to the MIDI In on the PCM 70, as shown in Figure 5.2. If your system includes one or more MIDI devices, the PCM 70 should be connected *after* the last device that will be used to control it.

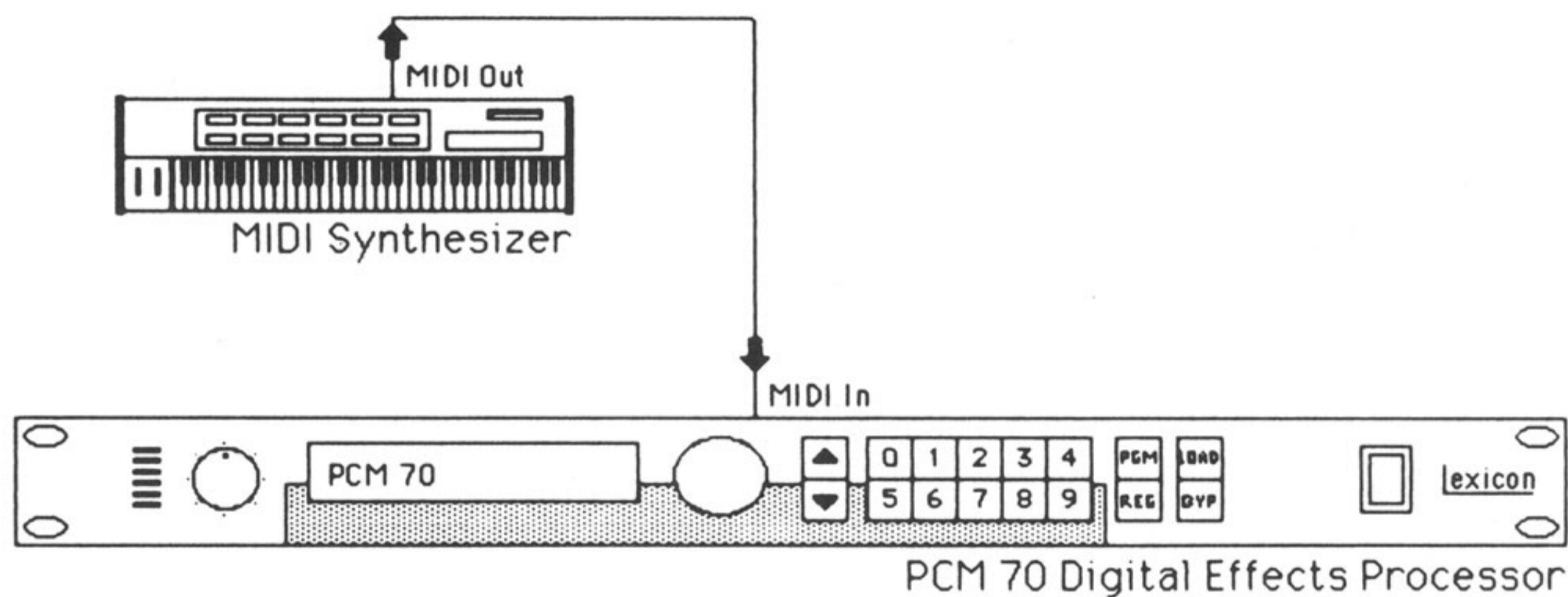

Figure 5.2. Connection to a synthesizer.

If your system includes a digital sequence recorder, connect the PCM 70 as shown in Figure 5.3.

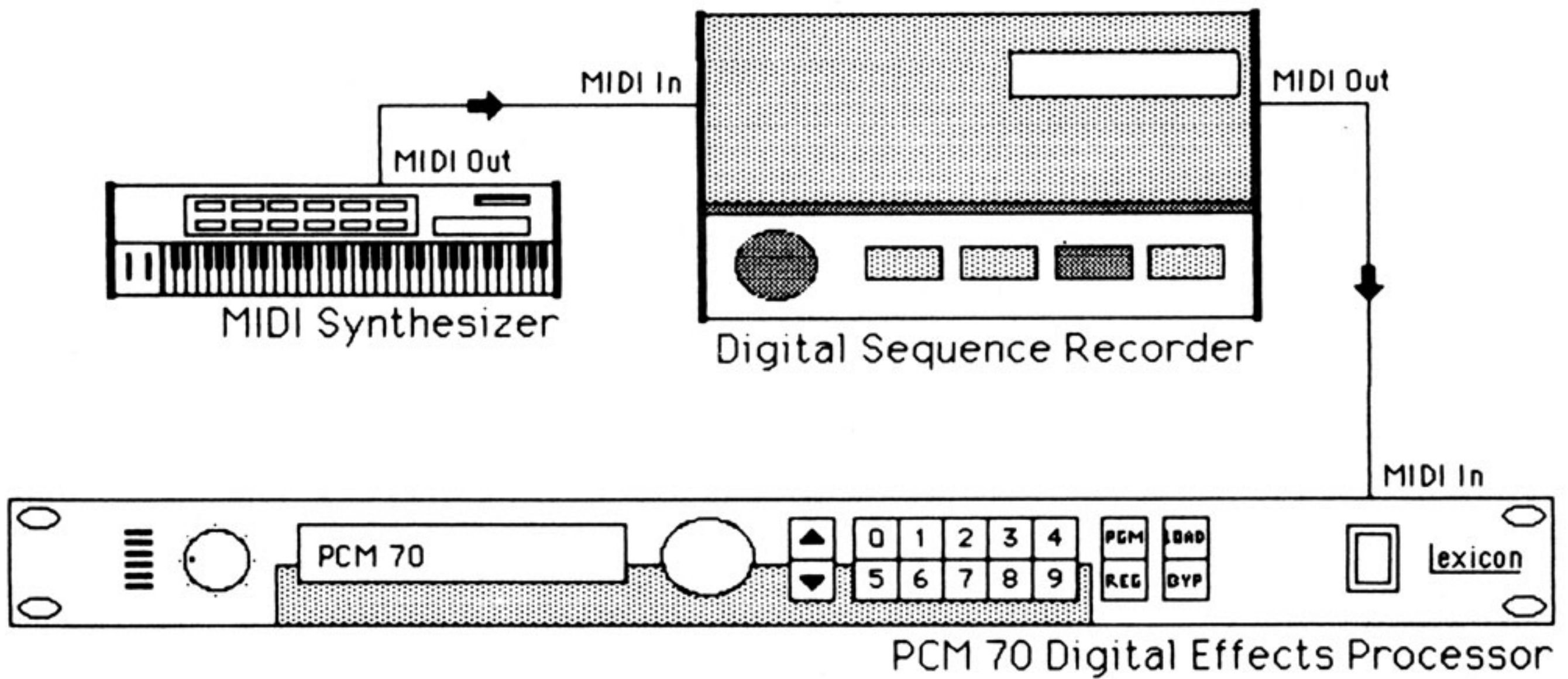

Figure 5.3. Connection with a Digital Sequence Recorder (Sequencer).

For an automated system which includes sync to tape, connect your system as shown in Figure 5.4.

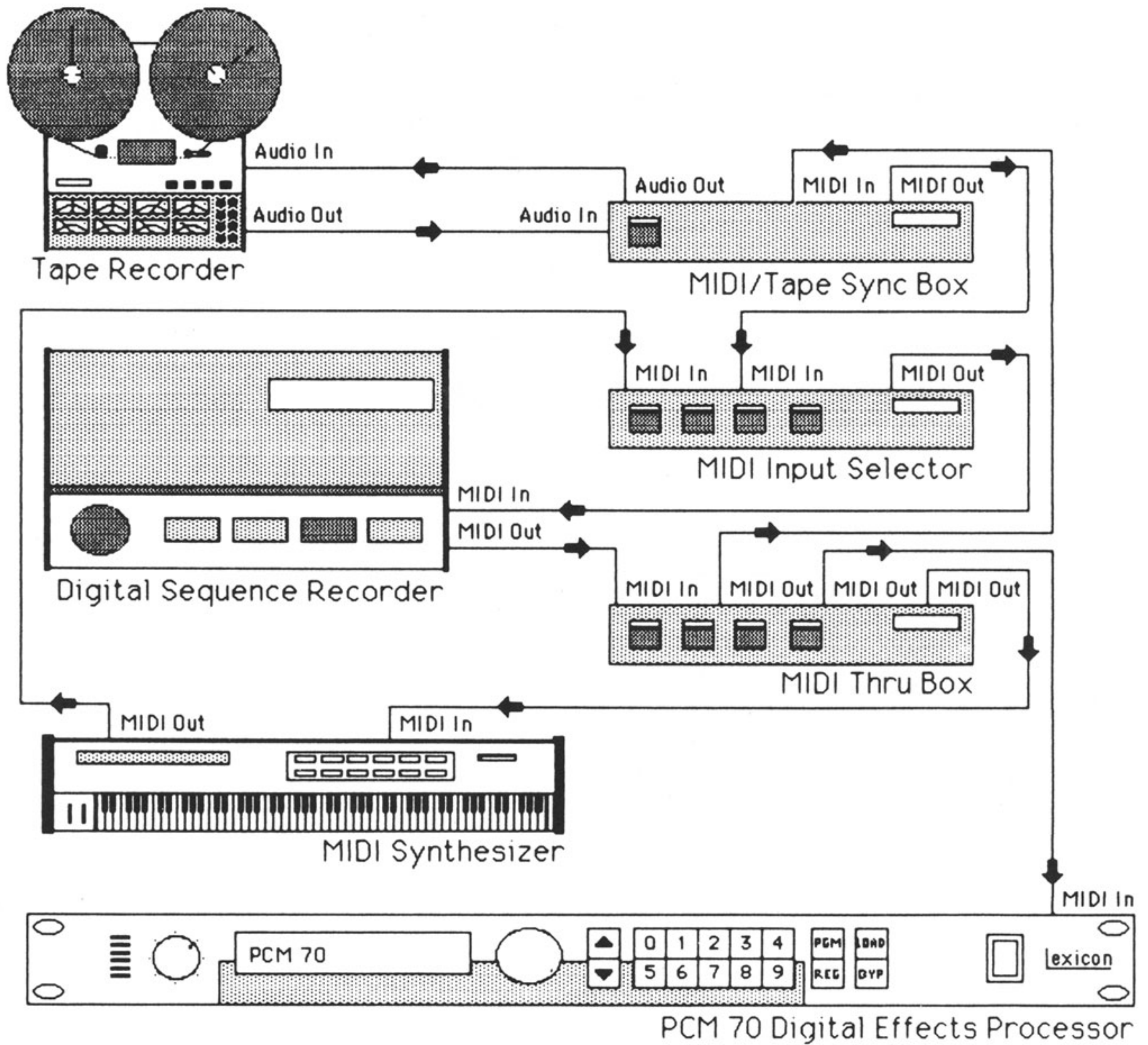

Figure 5.4. MIDI system with tape sync.

Because the PCM 70 sends program change commands as well as receiving them, it is possible to configure your system for sequenced program changes without using a keyboard, as shown in Figure 5.5. This configuration is most useful in recording situations, when your system also includes facilities for syncing the digital sequence recorder to tape.

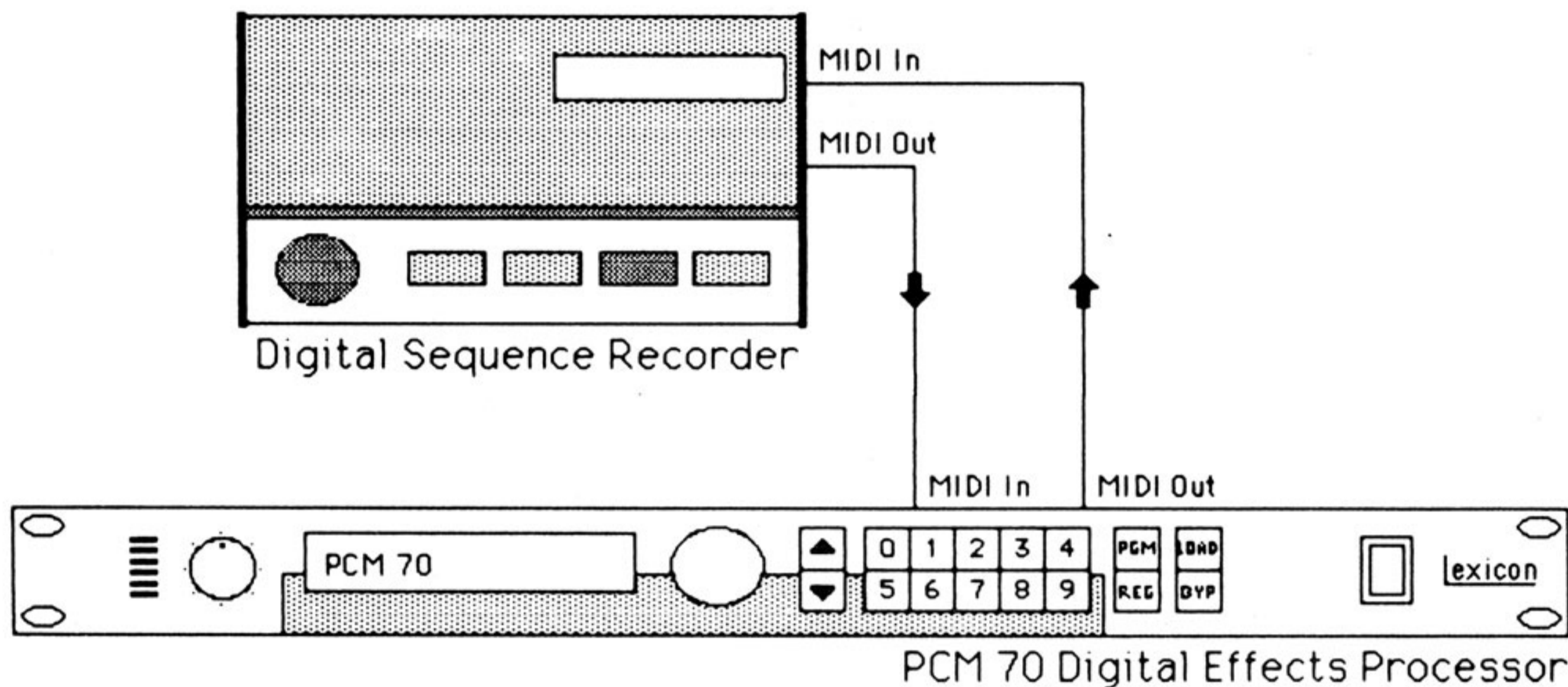

Figure 5.5 Connections for sequenced program changes.

Applications

Linking Two PCM 70s

Two PCM 70's can be linked for simultaneous program and register selection.

1. Connect your system as shown in Figure 5.1.
2. Load 7.0 CONTROL PROGRAM on both units.
3. Enter the parameter mode and select parameter 1.0 MIDI CHNL on both units. Set both units to the same channel.
4. Select parameter 1.1 OMNI MODE. Set it to OFF.
5. Select parameter 1.2 PGM CHANGE. Set it to FIX.
6. Select and load an effects or reverb program or register on the first PCM 70. The second unit will load the same program at the same time.

Using a MIDI Keyboard to Control the PCM 70

You can select PCM 70 registers or programs, and alter up to ten parameters simultaneously using the controllers found on MIDI-equipped instruments. Nearly any MIDI-equipped keyboard or synthesizer can be used to select registers and programs from the remote device. However, if you plan to control several PCM 70 parameters remotely, consider purchasing a keyboard (such as the Yamaha KX76 or KX88) specifically designed to function as a MIDI system controller. These keyboards have a large number of controllers, allowing you to control the PCM 70 without sacrificing control over your synthesizers and tone generators.

Choosing a MIDI Channel

For most applications, we recommend that you use OMNI OFF, and select a specific channel for the exclusive use of the PCM 70. Many users assign their instruments to the lower channels, and then jump to the higher channels (14, 15 and 16) for effects like the PCM 70. If you choose to operate with OMNI ON, be very careful not to accidentally send the PCM 70 commands you don't really want it to act on.

To choose a MIDI channel:

1. Select and Load 7.0 CONTROL PGM.
2. Enter the parameter mode and select parameter 1.0 MIDI CHNL. Set it to the channel you plan to use for remote control over the PCM 70. For now, just set it to channel 1, since many synthesizers only *output* MIDI data on channel 1.
3. Select parameter 1.1 OMNI MODE. Set it to OFF.
4. Select parameter 1.2 PGM CHANGE. Set it to FIX. We'll discuss the TABLE mode later in this chapter.

Remote Register and Program Selection

With parameter 1.2 PGM CHANGE set to FIX, when the PCM 70 and a keyboard are both in the OMNI mode *or* on the same channel, program changes made on the keyboard will cause an identical program change in the PCM 70. This is extremely useful since it allows you to tailor specific effects for each synthesizer program. Because the PCM 70 registers change at the same time as the synth programs, you are free to concentrate on your musical performance, without having to worry about selecting programs or registers on the PCM 70.

1. Make sure you have set up the PCM 70 MIDI channel and mode as described in steps 1-4 above.

2. Put the PCM 70 back in the program mode by briefly pressing the PGM key.
3. Select some programs on the synthesizer. The PCM 70 should select and automatically load a new program each time you select a program on the synthesizer. Note that when MIDI program change messages are received, the PCM 70 automatically loads the requested program, even when AUTOLOAD is off.

You may be confused about the relationship between the program number you select on the synth and the program number that is loaded on the PCM 70. When PGM CHNG is set to FIX, program change messages received from another MIDI device will be followed literally. Program change messages from 0 to 49 will load *registers* 0.0 to 4.9. Program change messages 50 and up will load *programs* 0.0 and up. So, for example, if you select program 23 on a synthesizer, register 2.3 will be loaded on the PCM 70. If you select program 64 on a synthesizer, program 1.4 will be loaded on the PCM 70.

Synthesizer manufacturers use different methods for numbering their presets--some (like Yamaha) number from 1 to 32, and others (like Korg) are arranged in banks, and number from 1.1 to 1.8, 2.1 to 2.8, and so forth. Whatever numbering method they use, however, selecting the first program sends a MIDI program change message 0, the second a MIDI program change message 1, and so on. If you experiment a bit, the relationship between your synthesizer's preset numbers and the programs and registers on the PCM 70 will become clear.

Using Corresponding Registers

You will quickly discover that a fixed relationship between synth program changes and PCM 70 program changes is not very convenient. It demands a very rigid relationship between programs in the PCM 70 and programs in your synths. Changing the program

contents of one or more of your synths can require a complete rearrangement of the registers in the PCM 70.

To solve this problem the PCM 70 has a *corresponding register table* which lets you assign any PCM 70 program or register to any MIDI program change number. This lets several synthesizer programs share the same PCM 70 register or program, making much better use of the PCM 70's registers. Most importantly, the corresponding register table saves you the work of having to rearrange the programs in the PCM 70 every time you change the programs in your MIDI instruments.

To use the corresponding register program:

1. Load program 7.1 COR REG TABLE.
2. Enter the parameter mode.
3. Use the up and down and 0-9 keys to move around the table. Notice that each location in the table corresponds to a MIDI program number--0.0 is program one, 0.1 is program two, etc.
4. Now turn the Soft Knob. Notice that any register or preset program can be assigned to a particular MIDI program number. Also, one or more MIDI program numbers can be set to IGNORE. No action will be taken when these MIDI program change numbers are received.

Remote Control of the PCM 70

Some extremely useful effects can be created when one or more of its parameters are controlled remotely, in real time. Many of the controllers found on a MIDI keyboard such as pitch benders, mod wheels, breath controllers, sliders, and switches can all be used to control the PCM 70. Events like last note played, velocity, and aftertouch can also be used.

To remotely control a parameter, you "patch" it to a MIDI controller or event, using the PATCH parameters found in the last row of most programs. There are ten patch locations for each program and register, allowing you to control up to 10 parameters remotely at the same time.

To get an idea of what patching can do for you, try the following example:

1. Load program 6.2, FILT ECHO PAN.
2. With the output of the PCM 70 plugged into a stereo monitoring system with good separation, run your fingers up and down the keyboard. Notice that the sound pans as you move across the keys.
3. Enter the parameter mode and select parameter 5.1. Play some notes on the keyboard. Notice that the pan setting in the display window changes as you move across the keys.

How does the PCM 70 do this? If you look at row 6 of program 6.2, FILT ECHO pan, you will notice that several of the Patch parameters are assigned to LAST NOTE. The notes you play on a synthesizer actually control the PCM 70's pan parameters! The programs in row 6 are preset for a variety of MIDI controllers and events, but you can create your own MIDI patches too.

Creating Your Own Patches

The PATCH parameter lets you use MIDI controllers and events to control the PCM 70.

1. With the PATCH parameter selected, rotate the Soft Knob. You will see a display of all the different MIDI controls and events that the PCM 70 will respond to.
2. When the controller you wish to use appears in the display window, press the LOAD key.

3. Now, use the Soft Knob to select the location number of the parameter you wish to remotely control. It may help to refer to the parameter tables found in Chapter 4 while doing this.
4. When the parameter you wish to control appears in the display window, press the LOAD key again.
5. Next, set the SCALING for the controller. SCALING sets the range of effectiveness for a MIDI controller, and it can be set in a range from 1 to 128. With SCALING set to 128, one step of a MIDI controller is equal to one click of the Soft Knob. With SCALING at 64, two steps of a MIDI controller are equal to one click of the SOFT KNOB. Use the Soft Knob to set the SCALING you wish to use and press the LOAD key.

Note: It is possible to set negative amounts of scaling. This allows you to have the PCM 70 *reduce* the setting of a parameter as the controller *increases*.

6. The parameter you chose in step 3 now appears in the display window. Use the Soft Knob to set the parameter value to the starting point you wish to use for MIDI control.

Control over a single PCM 70 parameter at a time is useful, but things really begin to get exciting as you experiment with controlling several PCM 70 parameters simultaneously from a single MIDI controller. For example, you might patch the mod wheel on a synth to control feedback and panning at the same time in the Chorus and Echo program. In effect, you are creating a custom MASTER control for a unique set of parameters. Using this custom MASTER in real time can easily produce stunning effects never heard before.

The ability to choose different settings of SCALING for two or more parameters controlled by the same event or controller

also raises some interesting possibilities. Don't forget that using *negative* SCALING for one parameter and *positive* SCALING for another will cause the first parameter to decrease while the other increases.

A word of caution: not all parameters respond well to real-time control. Due to the current limitations of digital technology, it is simply impossible to alter certain parameters in real time without audible artifacts. This is the case whether you are controlling the parameter remotely via MIDI, or from the unit's front panel. We considered locking out these parameters, but after careful thought we included them, since what is not acceptable in one application may not be a problem in another.

Experimentation is the key to success here. The following list contains some patches that we have tried with good results. You will undoubtedly find many more.

- Aftertouch or velocity to REVERB TIME
- Any event or control to REVERB TIME
- Any event or control to FEEDBACK
- Switches to 1/24th of a beat in BPM programs
- Switches to pitches in resonant chords (to change from one chord to another)
- Pitch Wheel to pitches in resonant chords
- Any event or control to MIX
- Volume to FX ADJ (in MIX = 100% applications)
- Note # to PITCH MST in resonant chords.

Some Notes On Controllers

Many MIDI synths and keyboards have a very limited number of controllers. On these devices, the pitch and modulation wheels or levers are the obvious choice for remotely controlling the PCM 70. However, you may not wish to produce modulation or pitch

bending at the same time that you are controlling the PCM 70. All is not lost. Most synths allow you to shut off the effect of these controllers. So, for example, moving the pitch bender doesn't actually bend pitch.

This is where things get interesting. Usually, when the synth is set to ignore its controllers, *controller data is still sent out over the MIDI port*. We have found this to be the case with a variety of different brands and models of synthesizers. As long as you don't wish to control the PCM 70 and bend pitch or add modulation at the same time, your synth's controllers can easily do double duty. Synthesizers which memorize ranges for the mod wheels and pitch benders for each preset program are the best choices for use with the PCM 70. By using the corresponding register table, you could have some programs use the pitch bender to bend pitch, and not affect the PCM 70, and others control the PCM 70, but not bend pitch.

The Yamaha DX7 when combined with a TX7, the Yamaha DX5 and DX1, and the Korg DW-6000 and DW-8000 come immediately to mind as synthesizers that can be used in this manner.

The Soft Knob as Controller

When setting up the PATCH parameters, you may have noticed that one of the options listed as potential MIDI controllers is the PCM 70's own Soft Knob. While the Soft Knob doesn't really qualify as a MIDI controller, it was included to allow non-MIDI users create their own custom MASTER controls. Everything we have said about using MIDI controllers with the PCM 70 applies equally to the Soft Knob. Because it is not a true MIDI controller however, changes made with the Soft Knob cannot be stored and repeated with a sequencer.

When the Soft Knob is specified as a controller with the PATCH parameter, you must select parameter 0.2 SOFT KNOB before it can be used.

Using a MIDI Sequencer to Control the PCM 70

Since you can control the PCM 70 in real time with MIDI controllers, it stands to reason that you could record your manipulation of those controllers with a MIDI sequencer, and then repeat the performance automatically. In fact, this works perfectly, and this capability gives the PCM 70 a fairly sophisticated level of automation. If your sequencer can sync to tape, you can even use it to provide automated effects for non-MIDI instruments. For example, you can control the PCM 70 from a keyboard, recording commands onto a sequencer, but the audio the PCM 70 processes might be percussion, guitar, vocals, or even the whole mix. If you perform live with sequencers, there is no reason why you can't sequence one or more PCM 70s along with everything else.

When working with sequencers, it is always a good idea to put the PCM 70 on a different MIDI channel than other devices in the system. This avoids the possibility of the PCM 70 responding to commands that aren't really intended for it.

Figure 5.3 shows basic connections for a keyboard, sequencer and PCM 70. Figure 5.4 shows connections for syncing the sequencer to tape. Describing the ins and outs of syncing sequencers to tape is beyond the scope of this manual. However, it is worth mentioning that when you sync a sequencer to tape, always record the sync track first, *alone*, and then go back and record any sequenced tracks while the sequencer, instruments, and effects are being driven by the sync track. If you record the sync track and one or more instruments at the same time, you are likely to encounter delay problems.

Transferring Registers Between Two PCM 70s

It is possible to transfer register data between two PCM 70s, via the MIDI port, using System Exclusive messages.

1. Connect the two units as shown in Figure 5.1, using a standard MIDI cable.
2. Turn off the unit you want to transfer register data *from*.
3. Now turn it on again. While the software version number is displayed, press the 7 key. The display window will read

SEND REGISTERS

4. Press the LOAD key. The registers from the first machine will be transferred to the second, and in a few moments the display window will read

DONE

Remote Control and Patch Storage with a Microcomputer

It is possible to use a microcomputer to remotely control the PCM 70, and also to store sets of registers. Several software houses are offering software compatible with the PCM 70. Because software is such a fast-changing market, in the interest of fairness, we will not list any specific manufacturers here. Check the pages of any of the popular keyboard and music magazines for more information.

Technical Descriptions of the Programs

The programs in the PCM 70 are derived from one of six high speed microcode programs for the digital audio processor. It may help you design your own effects if you understand how the sound flows through the processing routines of each program.

In the descriptions below, the bracketed numbers [n.n] refer to parameter location numbers by row and column.

Effects Programs

Chorus and Echo (Also Chorus and Rhythm)

Chorus and Echo is structured as a *MONO INPUT* feeding two distinct *DIFFUSERS* [0.6]. Each diffuser output is *HICUT* [0.5] filtered and feeds its own 432 ms delay line. When the diffuser is on, it adds an additional minimum delay of between 4 and 20 ms to the delay time shown on the display. This additional delay can be completely removed by setting *DIFFUSION* to 0. In applications which require precise delay time settings, or relatively short delay times (as in chorusing and flanging) *DIFFUSION* should be set to 0.

Voices 1 to 3 are taps from the first *DELAY* [1.1, 1.2, 1.3]. Voices 4 to 6 are taps from the second [1.4, 1.5, 1.6]. Each voice tap is individually *CHORUSED* [0.3, 0.4]. The chorused voices are fed to separate *FEEDBACK* [3.n] and output *LEVEL* [1.n] controls.

The feedback for a voice is fed back to the beginning of its delay line, after the diffuser, but before the filter. Therefore the recirculation is always filtered, but only diffused once. Each voice may be individually *PANNED* [4.n] to either left or right regardless of its diffuser/delay source.

Multiband Delay (Also Multiband Rhythm)

Multiband Delay has a single *DIFFUSER* [0.3] feeding a 936 ms delay line. When the diffuser is on, it adds an additional minimum delay of between 4 and 20 ms to the delay time shown on the display. This additional delay can be completely removed by setting *DIFFUSION* to 0. In applications which require precise delay time settings, or relatively short delay times (as in chorusing and flanging) *DIFFUSION* should always be set to 0.

Each *DELAY* [2.n] tap feeds individual sets of *LOCUT* [3.n] and *HICUT* [4.n] filters for each voice. Each voice also has individual *LEVEL* [1.n] and *PAN* [5.n] controls. The filters for voices 1, 2, and 3 have the most settings and a 12 dB/octave rolloff. The filters for voices 4 and 5 have 12 dB slopes, but are not settable to as many values. Voice 6 has a more gentle 6 dB/octave slope and a limited number of values.

Pre-fade *FEEDBACK* [0.4, 0.5] is available on voices 1 and 2. It is mixed with the input prior to the diffuser, so that the recirculated sound is repeatedly diffused and filtered.

Resonant Chords (Also Rhythmic Chords)

Resonant Chords has a single 773 ms delay line. Each PREDELAY [4.n] tap feeds individual HICUT filters grouped for control as HICUT LEFT [0.5] and HICUT RIGHT [0.6] for voices 1 to 3, and 4 to 6 respectively. Each filter feeds a delay line resonator whose length determines its PITCH [2.n]. The amount of feedback around the pitch delay line determines the amount of RESONANCE [3.n]. The sign of the resonance determines whether the note has the pitch shown and all its harmonics (positive) or a pitch one octave lower and odd harmonics (negative). The feedback is to the filter input so that the recirculated sound becomes progressively smoother.

The output of each resonator has individual LEVEL [1.n] and PANNING [5.n] controls. Each voice can be panned left or right independently of which hicut filter group it is in.

There are two separate overall FEEDBACK [0.3, 0.4] paths that are linked to the pre-delay tap settings of voices 3 and 6. The sound is picked off the delay line before the filter and resonator. The sound from tap 3 has negative feedback; tap 6 has positive feedback.

Reverb Programs

Concert Hall, Rich Chamber, Rich Plate

All of the reverb programs share the same basic structure. Sound is sent through a HICUT [0.6] filter to a delay line. The PREDELAY [0.5] tap feeds two separate diffusers with a common control, DIFFUSION [2.0]. The diffusers feed the reverberators which also have common controls. The static parameters, ATTACK [2.1] and DEFINITION [2.2], control the quality of the reverberation.

The reverb time parameters, REVERB TIME LOW [1.0], REVERB TIME MID [1.1], CROSSOVER [1.2], and REVERB TIME HICUT [1.3] control the frequency response and length of the decay.

The SIZE [0.3] control changes the lengths of the loops used in the reverberator structure and simulates changing the physical dimensions (in meters) of the acoustic space being recreated. Large sizes may also limit the amount of memory available for predelay and early reflections. This is most noticeable for very large sizes of Rich Chamber. The PCM 70 will tell you if you request a predelay too long for the size, and will give the maximum available. For example, the display

0.5 PDELAY > 116MS

results from requesting more than 116 ms of predelay for a Rich Chamber with a SIZE of 29.1 meters.

EARLY REFLECTIONS are unprocessed sound tapped directly from the delay line and sent unpanned to the left and right outputs. They may be used to simulate strong reflections off hard surfaces in real spaces, or for special effects. The Concert Hall program has four, and the Rich Chamber and Rich Plate have six. Their LEVEL [3.n] and DELAYS [4.n] are independent of each other and the reverberator. It is possible to have the early reflections arrive after the onset and decay of the reverberation.

Special Reverb Features

Gated Reverb

Each of the basic reverb programs can be gated, but generally the Rich Chamber or Rich Plate will sound better. The gate works by changing the reverberator from the running RT [1.0, 1.1] parameters to REVERB

TIME LOW STOP [1.4] and REVERB TIME MID STOP [1.5] when the current input level drops below an internally calculated threshold, for longer than the GATE [0.4] time. Artifacts of this parameter change may be audible on some program material, but can be minimized by using PREDELAY [0.5], typically around 24 ms.

Decay Optimization

This feature is available on all reverb programs and gives a more realistic timbre to long decays. If it produces artifacts on pure sounds that are varying slowly around its threshold, DECAY OPT [0.7] may be switched off.

Concert Hall Chorusing

CHORUSING [0.8] is unique to the Concert Hall reverb program and may be adjusted to give a more random decay characteristic.

Infinite Reverb

Infinite Reverb is a variation of Rich Chamber, set initially to its largest SIZE [0.3 = 32.6 meters] and longest non-infinite REVERB TIME [0.4 = 32 seconds]. Switching REV TIME to INF mutes the input and stops all the decay processes in the reverberator. The process is entirely digital so there is no degradation due to multiple analog/digital conversions. The REVERB DESIGN [1.n] row is used only to optimize the running reverb, since the reverb attack will average out in the recirculation.

Solving Problems

PCM 70 occasionally mutes audio and displays POWER LOW

Your power line voltage is too low for the PCM 70 to function reliably. It monitors line voltage and automatically shuts down when the voltage level falls 20% below the nominal line voltage that the unit is set for. Solution? You may have too many devices plugged into a single circuit--drawing too much current and pulling down the line voltage. Try turning off several devices and see if the problem goes away. If it does, the circuit is probably overloaded. Either permanently reduce the load on the circuit or have an electrician install a heftier circuit. If you must temporarily continue operations with the overloaded circuit, try plugging the PCM 70 into a VARIAC. This should only be done as a last resort in an emergency, since an overloaded electrical circuit represents a very real safety hazard to both you and your equipment.

PCM 70 seems confused--gibberish appears in the display window

The PCM 70 has extensive protection against power line noise, spikes, glitches, and hash, but like any computer-based device, its memory can become scrambled by power line noise. *The following procedure will solve this problem, but all user registers will be erased.* However, this procedure will not erase the factory preset programs.

To completely reset the PCM 70, turn off the power switch for a few moments, and then turn it back on. When the software version number appears on the display, press the 0 key.

After a few moments you will be asked

RESET MEMORY?

Press the LOAD key. You will be asked

ARE YOU SURE?

Press the 1 key. The PCM 70 will briefly flash

CLEARING MEMORY

and then load program 0.0. All registers will be erased and all control parameters will be returned to their factory preset settings.

When I plug the PCM 70 into my guitar amp, it sounds like I'm playing in a cavern

Check parameter 0.0 MIX on the programs and registers that you use. If it is set to 100% WET, reduce it to somewhere between 40 and 75%. 100% WET is primarily intended for use with consoles and amplifiers with an effects loop.

When connected to the effects loop on my console, turning up the console's effects send and returns just makes the dry signal louder

Check parameter 0.0 MIX on all the programs and registers you use. It should be set to 100% wet for proper operation in an effects loop.

PCM 70 displays "BATTERY LOW" when I turn it on

The PCM 70 has a lithium battery which maintains data memory (parameter settings, user registers, etc.) even when the unit is disconnected from power mains. The battery has a service life of up to five years.

When the battery is nearly exhausted, a "BATTERY LOW" message will appear in the display window each time you turn on the PCM 70. **Press the LOAD key to remove the message and continue on.** Contact Lexicon or a Lexicon dealer as soon as possible to have the battery replaced.

PCM 70 won't allow me to overwrite registers

The memory protection option is on. Read the section entitled Memory Protection in Chapter 2 to learn how to turn it off.

Specifications and MIDI Implementation Data

The following specifications are subject to change without notice.

Frequency Response

Processed Signal: 20 Hz to 15 kHz, ± 1 dB
 Direct Signal: 20 Hz to 20 kHz, ± 0.25 dB

Dynamic Range

Processed Signal: 80 dB, 20 Hz to 20 kHz noise bandwidth

Total Harmonic Distortion and Noise

Processed Signal: $< 0.05\%$ @ 1 kHz and full level
 Direct Signal: $< 0.025\%$ @ 1 kHz @ 3V out

Audio Input

Levels +4 dB; -8 to +18 dBV balanced
 -20 dB; -23 to +3 dBV unbalanced

Impedance +4 dB; 40 kilohms, paralleled with 150 pF (balanced)
 -20 dB; > 500 kilohms, paralleled with 150 pF (unbalanced)

Connector 1/4" tip/ring/sleeve phone jack

Audio Outputs (Two)

Levels +4 dB; +10 dBV into 600 ohms
 +16 dBV into > 10 kilohms
 -20 dB; -8 dBV into > 10 kilohms

Impedance 600 ohm unbalanced

Connectors 1/4" tip/ring/sleeve phone jack

Remote Bypass

1/4" tip/sleeve phone jack for latching footswitch (Lexicon A-FS-41)

Remote Register Select

1/4" tip/sleeve phone jack for momentary contact footswitch (Lexicon 750-02834)

Displays

FIP 16 digit, 14 segment alphanumeric fluorescent display

LEDs 5 segment headroom indicator with 24 dB range
Bypass, Program, Register, and Load button indicators

Power

Nominal 100, 120, 220, 240 Vac (-10%, +5%)
Switch-Selectable; 50-60 Hz, 25 W maximum

RFI Shielding

Meets FCC Class A computer equipment requirements

Protection

Mains fused; internal voltage and current limiting

Environment

Operating 0 to 35°C (32 to 95°F)
Storage -30 to 75°C (-22 to 167°F)
Humidity 95% maximum without condensation

Dimensions

Standard 19" rack mount; 19"w x 1 3/4"h x 13.5"d (483 x 45 x 344 mm)

Weight

10.7 lb (4.9 kg)
Shipping weight 12.5 lb (5.7 kg)

PCM 70 MIDI Implementation Chart

	Function...	Transmitted	Recognized	Remarks
Basic Channel	Default Changed	1-16 1-16	1-16 1-16	Saved in non-volatile memory
Mode	Default Messages Altered	x x *****	Mode 1.3 OMNI ON/OFF	Saved in non-volatile memory
Note Number	True Voice	x *****	0-127 x	See note 1
Velocity	Note ON Note OFF	x x	o x	See note 1
After Touch	Key's Ch's	x x	x o	See note 1
Pitch Bender		x	o	Default value = 40h
Control Change		x	0-31 64-95	See note 1 See note 1
Prog Change	True #	0 - 119 see note 3 *****	0 - 127 See note 2	See note 2
System Exclusive		o (bulk data only)	o	
System Common	Song Pos Song Sel Tune	x x x	x x x	
System Real Time	Clock Commands	x x	x x	
Aux Messages	Local On/Off All Notes Off Active Sense Reset	x x x x	x x x x	Resets MIDI patch sources to default values

Notes

- Note 1. Used as patch source, power-on default value = 0
- Note 2. Two Modes:
 Fixed: 00 - 49 = Registers 0.0 - 4.9,
 50 - 119 = Programs 0.0 - 6.9
 Table: 0-127 = Programmed to correspond to any program or register
- Note 3. Program changes are always transmitted in *Fixed* format

Mode 1: OMNI ON, POLY
 Mode 3: OMNI OFF, POLY

Mode 2: OMNI ON, MONO
 Mode 4: OMNI OFF, MONO

o : yes
 x : no

PCM 70 MIDI Implementation - Version 1.00

1. Transmitted Data

Status	Second	Third	Description
1100nnnn	0ppp pppp	-----	<p>Program Change</p> <p>ppppppp = 0 - 49 = Register 0.0 - 4.9 ppppppp = 50 - 119 = Program 0.0 - 6.9</p>

2. Recognized Receive Data

Status	Second	Third	Description
1001 nnnn	0kkk kkkk	0vvv vvvv	<p>NOTE ON kkkkkkk = 0-127*</p> <p>Velocity vvvvvvv = 1-127*</p>
1011 nnnn	0ccc cccc	0vvv vvvv	<p>cccccc = 0-31, continuous controller</p> <p>cccccc = 64-95, switch controllers</p> <p>0vvvvvvv = 0-127*</p>
1100 nnnn	0ppppppp	-----	<p>Program Change</p> <p>Fixed Mode: ppppppp = 0-49 = Reg 0.0-4.9 ppppppp = 50-119 = Pgm 0.0-6.9 ppppppp = 120-127 = ignored</p> <p>Table Mode: ppppppp = 0-127 TBL (ppppppp) = any Pgm or Reg</p>
1101 nnnn	0vvvvvvvv	-----	Channel Aftertouch vvvvvvvv = 0-127*
1110 nnnn	00000000	0vvvvvvvv	Pitch Bend vvvvvvvv = 0-127* (default = 64)
1011 nnnn	01111100	00000000	OMNI OFF
1011 nnnn	01111101	00000000	OMNI ON
1111 1111	-----	-----	RESET - resets MIDI patch source values to default (power-up) condition

*Used as a MIDI patch source value

I) Receive

A. Active/Stored Bulk Data (Single Register)

(hex)	F0		System Exclusive ID
	06		Lexicon ID
	00		PCM 70 ID
(bin)	oooc nnnn		c = 0 for active data (running program) c = 1 for stored data (register) n = MIDI channel 0-15 (0 = channel 1, etc.)
	oopp pppp		p = register # = 0-49 or 50 for the active data buffer
	oooo oobb	(02)	b = byte count of all data bytes = 334
	obbb bbbb	(4E)	(most significant bits sent first)
	oooo dddd	(hi)	d = data 167 bytes, sent in hi nybble/lo nybble pairs for a total of 334 bytes (see tables 2-9 for description)
	oooo dddd	(low)	
	osss ssss		sumcheck of nybbled data bytes (high bit = 0)
(hex)	F7		End of Exclusive Message

Important Note: The PCM 70 requires 30 ms. between stored bulk data messages.

B. Parameter Data

(hex)	F0		System Exclusive ID
	06		Lexicon ID
	00		PCM 70 ID
(bin)	oo1o nnnn		n = MIDI channel 0 - 15 (0 = channel 1)
	oggg gggg		g = parameter # 0 - 89 (see table 1)
	oooo ovvv		v = parameter value - 10 bits; most significant bits sent first (see tables for parameter limits)
	ovvv vvvv		
(hex)	F7		End of Exclusive Message

C. Requests

(hex)	F0		System Exclusive ID
	06		Lexicon ID
	00		PCM 70 ID
(bin)	oo11 nnnn		n = MIDI channel 0 - 15 (0 = channel 1)
	oooo eeee		e = event code: (hex) 60 = send active bulk data (hex) 61 = send stored bulk data
	oppp pppp		p = register # = 0 - 49 or 50 for active data
(hex)	F7		End of Exclusive Message

II) Transmitted

A. Active/Stored Bulk Data (single register)

Sent on receipt of system exclusive request or via front panel "Send Registers" diagnostic.

B. Parameter Changes

Not sent from the PCM 70 via MIDI.

TABLE 1: Parameter Numbering for System Exclusive Messages

Parameter #	Parameter
0 - 59	Number corresponds to (10* row) + column
60 - 69	Patch Sources (10)
70 - 79	Patch Destinations (10)
80 - 89	Patch Scale Factors (10)
90 - 103	Name (14)

TABLE 2: General Bulk Data Format

Byte #	Data
0	Program Type (see Table 3)
1	Stored Parameter Matrix Position: Row
2	Stored Parameter Matrix Position: Column
3 - 16	Name (14 characters; last character must be 0)
17 - 26	MIDI Patch Sources
27 - 36	MIDI Patch Destinations
37 - 46	MIDI Scale Factors
47 - 167	60 2-byte words, different for each program type. See Tables 4-9.

2-byte words are in the following form:

Byte			
0	dddd dddd	Low	8 bits
1	oooo oddd	High	2 bits

TABLE 3: Program Types

0	Unused
1 - 3	Not Available
4	Chorus and Echo
5	Multiband
6	Resonant Chords
7	Concert Hall
8	Rich Chamber
9	Rich Plate
10	Infinite Reverb
11	Multiband Rhythm
12	Chorus and Rhythm
13	Rhythmic Chords

TABLE 4: Chorus and Echo; Chorus and Echo BPM

Row #	Byte #	Description	Param #	Min.	Max	Display
0	47,48	MIX	0	462	562	0% - 100%
	49,50	FX ADJ	1	461	563	-90 - +12dB
	51,52	SOFT KNOB	2	448	575	0 - 127
	53,54	CHORUSING	3	462	561	0 - 99
	55,56	CHORUS	4	506	518	OFF, 1 VCS - 6 VCT
	57,58	HC	5	496	527	0Hz - 15.0KHz
	59,60	DIFFUSION	6	462	561	0 - 99
	61,62	(Not Available)				
	63,64	" "				
	65,66	" "				
1	67,68	LVL MST	10	477	547	-35 - +35
	69,70	V1 LVL	11	495	530	OFF - FULL
	71,72	V2 LVL	12	"	"	" "
	73,74	V3 LVL	13	"	"	" "
	75,76	V4 LVL	14	"	"	" "
	77,78	V5 LVL	15	"	"	" "
	79,80	V6 LVL	16	"	"	" "
2	81,82	DLY MST	20	260	764	-252 - +252ms
	83,84	V1 DLY	21	386	638	0 - 432ms
	85,86	V2 DLY	22	"	"	" "
	87,88	V3 DLY	23	"	"	" "
	89,90	V4 DLY	24	"	"	" "
	91,92	V5 DLY	25	"	"	" "
	93,94	V6 DLY	26	"	"	" "
3	95,96	FDBK MST	30	318	706	-194 - +194
	97,98	V1 FDBK	31	415	609	-97% - +97%
	99,100	V2 FDBK	32	"	"	" "
	101,102	V3 FDBK	33	"	"	" "
	103,104	V4 FDBK	34	"	"	" "
	105,106	V5 FDBK	35	"	"	" "
	107,108	V6 FDBK	36	"	"	" "
4	109,110	PAN MST	40	412	612	-100 - +100
	111,112	V1 PAN	41	462	562	50L - 50R
	113,114	V2 PAN	42	"	"	" "
	115,116	V3 PAN	43	"	"	" "
	117,118	V4 PAN	44	"	"	" "
	119,120	V5 PAN	45	"	"	" "
	121,122	V6 PAN	46	"	"	" "
	123-167	(Not Available)				

*Limits for BPM version

TABLE 5: Multiband Delay; Multiband Delay BPM

Row #	Byte #	Description	Param #	Min.	Max	Display
0	47,48	MIX	0	462	562	0% - 100%
	49,50	FX ADJ	1	461	563	-90 - +12dB
	51,52	SOFT KNOB	2	448	575	0 - 127
	53,54	DIFFUSION	3	462	561	0 - 99
	55,56	V1 FDBK	4	"	"	" "
	57,58	V2 FDBK	5	"	"	" "
	59,60	(Not Available)				
	61,62	" "				
	63,64	" "				
	65,66	" "				
1	67,68	LVL MST	10	477	547	-35 - +35
	69,70	V1 LVL	11	495	530	OFF - FULL
	71,72	V2 LVL	12	"	"	" "
	73,74	V3 LVL	13	"	"	" "
	75,76	V4 LVL	14	"	"	" "
	77,78	V5 LVL	15	"	"	" "
	79,80	V6 LVL	16	"	"	" "
2	81,82	DLY MST*	20	292	732	-315 - +315
	83,84	V1 DLY*	21	354	669	0 - 936ms
	85,86	V2 DLY	22	"	"	" "
	87,88	V3 DLY	23	"	"	" "
	89,90	V4 DLY	24	"	"	" "
	91,92	V5 DLY	25	"	"	" "
	93,94	V6 DLY	26	"	"	" "
3	95,96	LC MST	30	481	543	-30 - +30
	97,98	V1 LC	31	496	527	0Hz - 13.6KHz
	99,100	V2 LC	32	"	"	" "
	101,102	V3 LC	33	"	"	" "
	103,104	V4 LC	34	"	"	" "
	105,106	V5 LC	35	"	"	" "
	107,108	V6 LC	36	"	"	" "
4	109,110	HC MST	40	481	543	-30 - +30
	111,112	V1 HC	41	496	527	170Hz - 15.0KHz
	113,114	V2 HC	42	"	"	" "
	115,116	V3 HC	43	"	"	" "
	117,118	V4 HC	44	"	"	" "
	119,120	V5 HC	45	"	"	" "
	121,122	V6 HC	46	"	"	" "
5	123,124	PAN MST	50	412	612	-100 - +100
	125,126	V1 PAN	51	462	562	50L - 50R
	127,128	V2 PAN	52	"	"	" "
	129,130	V3 PAN	53	"	"	" "
	131,132	V4 PAN	54	"	"	" "
	133,134	V5 PAN	55	"	"	" "
	135,136	V6 PAN	56	"	"	" "
	137-166	(Not Available)				

*Limits for BPM version

TABLE 6: Resonant Chords

Row #	Byte #	Description	Param #	Min.	Max	Display
0	47,48	MIX	0	462	562	0% - 100%
	49,50	FX ADJ	1	461	563	-90 - +12dB
	51,52	SOFT KNOB	2	448	575	0 - 127
	53,54	V3 FDBK	3	462	561	0 - -99
	55,56	V6 FDBK	4	462	561	0 - 99
	57,58	HFC LEFT	5	496	527	170Hz - 15.0KHz
	59,60	HFC RIGHT	6	496	527	170Hz - 15.0KHz
	61,62	(Not Available)				
	63,64	" "				
65,66	" "					
1	67,68	LVL MST	10	477	547	-35 - +35
	69,70	V1 LVL	11	495	530	OFF - FULL
	71,72	V2 LVL	12	"	"	" "
	73,74	V3 LVL	13	"	"	" "
	75,76	V4 LVL	14	"	"	" "
	77,78	V5 LVL	15	"	"	" "
	79,80	V6 LVL	16	"	"	" "
2	81,82	PCH MST	20	438	586	-74 - +74
	83,84	V1 PITCH	21	475	549	Db1 - Eb7
	85,86	V2 PITCH	22	"	"	" "
	87,88	V3 PITCH	23	"	"	" "
	89,90	V4 PITCH	24	"	"	" "
	91,92	V5 PITCH	25	"	"	" "
	93,94	V6 PITCH	26	"	"	" "
3	95,96	RESN MST	30	318	706	-194 - +194
	97,98	V1 RESN	31	415	609	-97% - +97%
	99,100	V2 RESN	32	"	"	" "
	101,102	V3 RESN	33	"	"	" "
	103,104	V4 RESN	34	"	"	" "
	105,106	V5 RESN	35	"	"	" "
	107,108	V6 RESN	36	"	"	" "
4	109,110	PDL MST*	40	308	716	-204 - +204
	111,112	V1 PDL*	41	410	614	0 - 773ms
	113,114	V2 PDL	42	"	"	" "
	115,116	V3 PDL	43	"	"	" "
	117,118	V4 PDL	44	"	"	" "
	119,120	V5 PDL	45	"	"	" "
	121,122	V6 PDL	46	"	"	" "
5	123,124	PAN MST	50	412	612	-100 - +100
	125,126	V1 PAN	51	462	562	50R - 50L
	127,128	V2 PAN	52	"	"	" "
	129,130	V3 PAN	53	"	"	" "
	131,132	V4 PAN	54	"	"	" "
	133,134	V5 PAN	55	"	"	" "
	135,136	V6 PAN	56	"	"	" "
	137-166	(Not Available)				

*Limits for BPM version

TABLE 7: Concert Hall

Row #	Byte #	Description	Param #	Min.	Max	Display
0	47,48	MIX	0	462	562	0% - 100%
	49,50	FX ADJ	1	461	563	-80 - +12dB
	51,52	SOFT KNOB	2	448	575	0 - 127
	53,54	SIZE (49)	3	491	532	5.6 - 34.7m
	55,56	GATE TIME	4	384	639	0ms - 4.57s/OFF
	57,58	PDELAY	5	385	638	0 - 506ms**
	59,60	HC	6	497	527	170Hz - 15.0KHz
	61,62	DCY OPT	7	512	513	OFF - ON
	63,64	(Not Available)				
	65,66	" "				
1	67,68	RT LOW	10	496	527	depends on size
	69,70	RT MID	11	"	"	depends on size
	71,72	XOVER	12	"	"	0Hz - 15.0 KHz
	73,74	RT HC	13	"	"	0Hz - 15.0 KHz
	75,76	RTL STOP	14	"	"	depends on size
	77,78	RTM STOP	15	"	"	depends on size
2	79,80	DIFFUSION	10	462	561	0 - 99
	81,82	ATTACK	11	"	"	" "
	83,84	DEFINITION	12	"	"	" "
3	85,86	REFL LVL MSTR	20	472	547	-35 - +35
	87,88	REFL L1	21	495	530	OFF- FULL
	89,90	REFL L2	22	"	"	" "
	91,92	REFL L3	23	"	"	" "
	93,94	REFL R1	24	"	"	" "
	95,96	REFL R2	25	"	"	" "
	97,98	REFL R3	26	"	"	" "
4	87,88	REFL DLY MSTR	30	206	818	-306 - +306
	89,90	REFL L1	31	400	624	0 - 728ms**
	91,92	REFL L2	32	"	"	" "
	93,94	REFL L3	33	"	"	" "
	95,96	REFL R1	34	"	"	" "
	97,98	REFL R2	35	"	"	" "
	99,100	REFL R3	36	"	"	" "

**Limits depend on size

TABLE 8: Rich Chamber and Rich Plate

Row #	Byte #	Description	Param #	Min.	Max	Display	
0	47,48	MIX	0	462	562	0% - 100%	
	49,50	FX ADJ	1	461	563	-80 - +12dB	
	51,52	SOFT KNOB	2	448	575	0 - 127	
	chamber	53,54	SIZE (38)	3	493	531	5.6 - 32.6m
		53,54	SIZE (41)	3	491	532	5.6 - 34.7m
	plate	55,56	GATE TIME	4	384	639	0ms - 4.57s/OFF
		57,58	PDELAY	5	385	638	0 - 506ms**
		59,60	HC	6	497	527	170Hz - 15.0KHz
		61,62	DCY OPT	7	512	513	OFF - ON
63,64		(Not Available)					
65,66	" "						
1	67,68	RT LOW	10	496	527	depends on size	
	69,70	RT MID	11	"	"	depends on size	
	71,72	XOVER	12	"	"	OHZ - 15.0 KHz	
	73,74	RT HC	13	"	"	OHZ - 15.0 KHz	
	75,76	RTL STOP	14	"	"	depends on size	
	77,78	RTM STOP	15	"	"	depends on size	
2	79,80	DIFFUSION	10	462	561	0 - 99	
	81,82	ATTACK	11	"	"	" "	
	83,84	DEFINITION	12	"	"	" "	
3	85,86	REFL LVL MSTR	20	472	547	-35 - +35	
	87,88	REFL L1	21	495	530	OFF - FULL	
	89,90	REFL L2	22	"	"	" "	
	91,92	REFL L3	23	"	"	" "	
	93,94	REFL R1	24	"	"	" "	
	95,96	REFL R2	25	"	"	" "	
	97,98	REFL R3	26	"	"	" "	
4	87,88	REFL DLY MSTR	30	206	818	-306 - +306	
	89,90	REFL L1	31	400	624	0 - 728ms**	
	91,92	REFL L2	32	"	"	" "	
	93,94	REFL L3	33	"	"	" "	
	95,96	REFL R1	34	"	"	" "	
	97,98	REFL R2	35	"	"	" "	
	99,100	REFL R3	36	"	"	" "	

**Limits depend on size

TABLE 9: Infinite Reverb

Row #	Byte #	Description	Param #	Min.	Max	Display
0	47,48	MIX	0	462	562	0% - 100%
	49,50	FX ADJ	1	461	563	-80 - +12dB
	51,52	SOFT KNOB	2	448	575	0 - 127
	53,54	SIZE (38)	3	493	531	5.6 - 32.6m
	55,56	REV TIME	4	496	528	.04 - INF*
	57,58	PDELAY	5	20	5FH	0 - 506**
	59,60	HC	6	497	527	170Hz - 15.0KHz
	61,62	(Not Available)				
	63,64	" "				
	65,66	" "				
1	67,68	DIFFUSION	10	462	561	0 - 99
	69,70	ATTACK	11	"	"	" "
	71,72	DEFINITION	12	"	"	" "
2	73,74	REFL LVL MSTR	20	472	547	-35 - +35
	75,76	REFL L1	21	495	530	OFF- FULL
	77,78	REFL L2	22	"	"	" "
	79,80	REFL L3	23	"	"	" "
	81,82	REFL R1	24	"	"	" "
	83,84	REFL R2	25	"	"	" "
	85,86	REFL R3	26	"	"	" "
3	87,88	REFL DLY MSTR	30	206	818	-306 - +306
	89,90	REFL L1	31	400	624	0 - 506ms**
	91,92	REFL L2	32	"	"	" "
	93,94	REFL L3	33	"	"	" "
	95,96	REFL R1	34	"	"	" "
	97,98	REFL R2	35	"	"	" "
	99,100	REFL R3	36	"	"	" "

*Display depends on size

**Limits depend on size

Relating Stored Parameter Values to Numbers Displayed

1. Size Display

Program	Minimum Size	Time Const.	Size Const.	Size Base
Concert Hall	5	444	164	31362
Rich Chamber	8	388	511	30151
Rich Plate	8	471	424	30892
Inf. Reverb	8	388	511	30151

Calculating displayed size:

$$\text{displayed size} = (\text{size value} + \text{minimum size}) * 71 / 10$$

where minimum size is the value found in the table above, and size value is found as follows:

$$\text{size value} = \text{"size" parameter value} - \text{"size" parameter low limit}$$

Parameter values and low limits are found in tables 4 - 9. Final results are rounded to the nearest integer.

2. Reverb Time Display

Calculate size value as above. Then define size factor, time factor and time value by the following, each rounded to the nearest integer:

$$\begin{aligned} \text{size factor} &= [(\text{size value} * 10) / \text{minimum size}] + 10 && \text{(see table 10)} \\ \text{time factor} &= (\text{size factor} * \text{time constant}) / 1000 && \text{(see table 10)} \\ \text{time value} &= \text{"time" parameter value} - \text{"time" parameter low limit} \end{aligned}$$

(See table 10 for time constants and tables 4 - 9 for parameter values and low limits)
Then displayed time in milliseconds (rounded to the nearest integer) is given by:

$$\text{displayed time} = (\text{time factor} * \text{table11}[\text{time value}]) / 500$$

3. Level Parameter Display

Define level value analogously to size value and time value. Then

$$\text{displayed level} = \text{table12}[\text{level value}]$$

4. Reverb Predelay Display

$$\text{displayed predelay} = \text{value} * 2 \quad \text{(milliseconds)}$$

where value is defined analogously to level value in item 3.

5. Gate Time Display

displayed gate time = value * 18 (milliseconds)

where value is defined analogously to level value in item 3.

6. Frequency Display

displayed frequency = table13[value]

where value is defined analogously to level value in item 3.

7. Delay Time Display (Not for Resonant Chords)

Parameter Value	Displayed Delay Time
0 - 97	see below*
98 - 147	value - 48
148 - 197	(value - 98) * 2
198 - 247	(value - 148) * 4
248 - up	(value - 198) * 8

*get samples = table14[value]; then calculate:

displayed delay time = (samples * 148)/50 (rounded to nearest integer)

8. Chorus Display

Parameter Value	Displayed Chorus Type
0	OFF
1 - 6	1VC S - 6VC S
7 - 12	1VC T - 6VC T

9. Patch Source Display

Parameter Value	Displayed Patch Source
0	OFF
1 - 32	Controls 0 - 31
33 - 64	Switches 64 - 95
65	Pitch Wheel
66	After Touch
67	Last Note
68	Last Velocity
69	Soft Knob
70	Midi Clock (not implemented in version 2.0)

10. Patch Destination Display

displayed value = (row * 10) + column

11. Patch Scale Factor Display

Parameter Value		Displayed Patch Scale Factor
0 - 127		-128 - -1
128 - 255	+1 - +128	

TABLE 10: Reverberation Minimum Sizes and Time Constants

Program Type	Minimum Size	Time Constant
Rich Chamber	8	388
Rich Plate	8	471
Concert Hall	5	444
Infinite Reverb	8	388

TABLE 11: Reverberation Times

5	6	8	9	11	12	13	14	15	17
18	20	22	24	26	28	30	34	38	42
46	52	57	65	75	85	100	120	160	220
350	700								

Note: table11[value] is found by starting at the top left and counting out, row by row "value" entries. Thus, the row and column of the desired entry will be such that $value = (row * 10) + column$.

TABLE 12: Levels

OFF	-30	-27	-24	-22	-21	-19	-18	-17	-16
-15	-14	-13	-12	-11	-10	-9.5	-9.0	-8.5	-8.0
-7.5	-7.0	-6.5	-6.0	-5.5	-5.0	-4.5	-4.0	-3.5	-3.0
-2.5	-2.0	-1.5	-1.0	-0.5	FULL				

Note: to find table12[value] see table 11 above.

TABLE 13: Frequencies

0	170	350	530	720	920	1120	1330	1550	1780
2020	2270	2530	2810	3100	3410	3730	4080	4450	4850
5280	5750	6270	6830	7470	8190	9020	10000	11100	12300
13600	15000								

Note: to find table13[value] see table 11 above. Results are in Hertz.

TABLE 14: Sample Table for Delay Times

0	1	2	4	6	8	10	13	16	20
24	28	33	38	43	49	55	61	67	74
81	89	97	105	114	123	132	142	152	162
173	184	195	207	219	231	244	257	270	284
298	312	327	342	358	374	390	406	423	440
457	475	493	512	531	550	569	589	609	629
650	671	693	715	737	759	782	805	829	853
877	902	927	952	977	1003	1029	1056	1083	1110
1138	1166	1194	1222	1251	1280	1310	1340	1370	1401
1432	1463	1495	1527	1559	1592	1625	1659	1692	1726
1760	1794	1827	1861	1895	1929	1963	1997	2031	2064
2098	2132	2166	2200	2234	2268	2302	2336	2370	2404
2437	2471	2505	2539	2573	2607	2641	2674	2708	2742
2776	2810	2844	2877	2911	2945	2979	3013	3047	3081
3114	3148	3182	3216	3250	3284	3318	3351	3385	3453
3521	3588	3656	3724	3792	3859	3927	3995	4062	4096
4198	4266	4333	4401	4469	4536	4604	4672	4739	4807
4875	4943	5010	5078	5146	5213	5281	5349	5417	5484
5552	5620	5687	5755	5823	5890	5958	6026	6094	6161
6229	6297	6364	6432	6500	6568	6635	6703	6771	6906
7042	7177	7312	7448	7583	7719	7854	7989	8125	8260
8396	8531	8667	8802	8937	9073	9208	9344	9479	9614
9750	9885	10021	10156	10292	10427	10562	10698	10833	10969
11104	11239	11375	11510	11646	11781	11917	12052	12187	12323
12458	12594	12729	12864	13000	13135	13271	13406	13542	13812
14083	14354	14625	14896	15167	15437	15708	15979	16250	16521
16792	17062	17333	17604	17875	18146	18417	18687	18958	19229
19500	19770	20041	20312	20583	20854	21125	21396	21666	21937
22208	22479	22750	23021	23291	23562	23833	24104	24375	24646
24916	25187	25458	25729	26000	26271	26541	26812	27083	27354
27625	27896	28166	28437	28708	28979	29250	29521	29792	30062
30333	30604	30874	31145	31416	31687				

PCM 70 Register Contents Record

Register Name Number

Original Program Name Number

0.0	0.1	0.2	0.3	0.4	0.5	0.6	0.7	0.8	0.9
1.0	1.1	1.2	1.3	1.4	1.5	1.6	1.7	1.8	1.9
2.0	2.1	2.2	2.3	2.4	2.5	2.6	2.7	2.8	2.9
3.0	3.1	3.2	3.3	3.4	3.5	3.6	3.7	3.8	3.9
4.0	4.1	4.2	4.3	4.4	4.5	4.6	4.7	4.8	4.9
5.0	5.1	5.2	5.3	5.4	5.5	5.6	5.7	5.8	5.9
6.0	6.1	6.2	6.3	6.4	6.5	6.6	6.7	6.8	6.9

Parameter Settings Table

Notes
